

Assemble Instruction of Geeetech Prusa I3 pro W 3D Printer

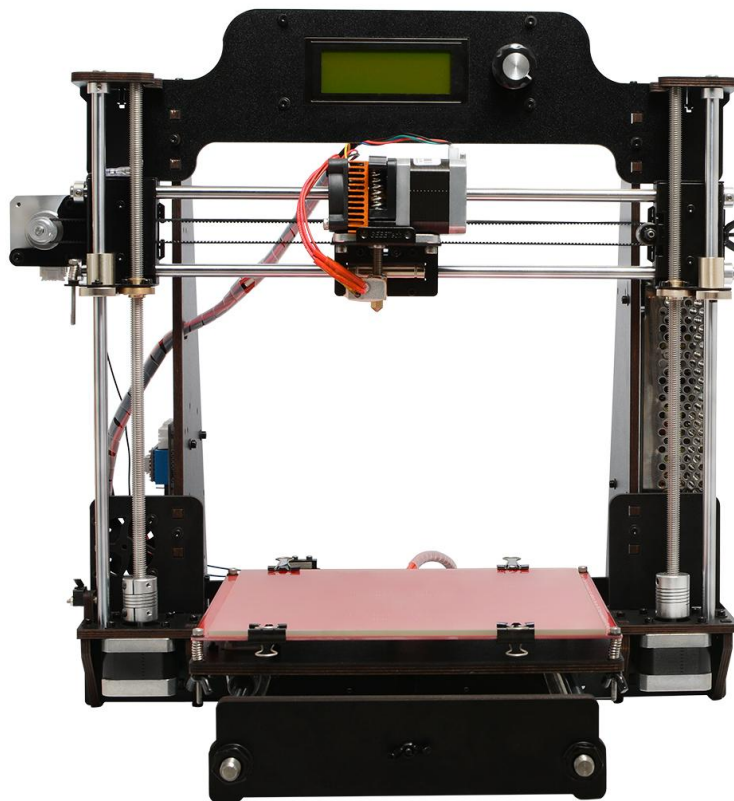

Version 05-31-2017

Contents

Safety Instructions	2
Preparations	3
1.Unfold the box and check the package	4
2 Assemble the rods of a Y axis.....	6
3 Assemble Y axis support plates.....	9
4 Mount the Y Motor	11
5 Build the printing platform	14
6 Assemble the Y idler.....	20
7 Mount the Y –axis belt.....	23
8 Mount the End stop of Y-axis	25
9 Assemble the XZ frame and the side panel.....	26
10 Assemble the 2 Z motors support	31
11 Mount the fan.....	37
12 Assemble Y - Z axis.....	38
13 Mount Z-axis End stop.....	42
14 Mount the 2 Z motors	43
15 Mount the coupling.....	45
16 Assemble the X-axis motor end.....	49
16.1 Assemble the Linear bearing and Z axis nut.....	49
16.2 Mount X-axis motor.....	51
16.3 Mount the end stop and the endstop trigger.....	53
17 Assemble X axis idler end	55
18 Assemble the extruder carriage.....	56
19 Assemble the X&Z axis	61
20 Assemble the Z axis top mount.....	67
21 Mount the extruder.....	72
22 Assemble X idler.....	74
23 Add the X axis belt	77
24 Mount the LCD panel	81
25 Attach the heated bed.....	83
26 Mount the PSU.....	85
27 Mount the control board.....	94
28 Wiring	97
29 Tidy out the wires	110
30 Mount the filament spool.	111
31 Warm tips.....	112

Safety Instructions

Building the printer will require a certain amount of physical dexterity, common sense and a thorough understanding of what you are doing. We have provided this detailed instruction to help you assemble it easily.

However ultimately we cannot be responsible for your health and safety whilst building or operating the printer, with that in mind be sure you are confident with what you are doing prior to commencing with building or buying. Read the entire manual to enable you to make an informed decision.

Building and operating involves electricity, so all necessary precautions should be taken and adhered to, the printer runs on 12V supplied by a certified power supply, so you shouldn't ever have to get involved with anything over 12V but bear in mind there can still be high currents involved and even at 12V they shouldn't be taken lightly.

High temperatures are involved with 3D Printing, the Extrusion nozzle of the hot end can run about 230 °C, the heated bed runs 110 °C and the molten plastic extruded will initially be at around 200 °C, so special care and attention should be made when handling these parts of the printer during operation.

We wouldn't recommend leaving your printer running unattended, or at least until you are confident to do so. We cannot be held responsible for any loss, damage, threat, hurt or other negligent result from either building or using the printer.

Preparations

1. Unpack the kit and check if all parts are in the box and check the condition of each part, there might be some damage during shipping. To help you with this, there is BOM in the box and each bag was labeled with part number.
2. Contact our customer service immediately by email or through the website if you find any missing or damaged parts. And on the bottom of the BOM, there is a signature of reviewer, please take a picture of it and attach the picture in your mail.
3. Before you start, you can put all the part in order to save your time especially those screws and nuts. Do not mix them up.
4. Ensure you have the necessary skills to carry out the work, or enlist the help of someone who does.
5. Work on a big firm table or bench in a clean dry well-lit area.
6. This kit contains tiny parts; please keep them away from kids under 3.
7. Ask for help if you run into any problems - our contact details are on the website and we will always do our best to resolve any problems encountered.
8. Watch the building instruction videos here on YouTube:

<https://www.youtube.com/playlist?list=PLODCkot3GrigDNAiLi4PDbKfZE41VtgG>

Read through each chapter of these instructions to gain an over-all idea of what is involved and how long it might take, before starting on the work described.

1.Unfold the box and check the package

Unfold the package and take all the parts out to check the condition of the items. As you can see, all the parts are packed very carefully.









Tips:

1. Before assembly, you are advised to put all the parts in order, especially the screws and nuts in order, which will save you a lot of time looking for the required parts.
2. The part ID is corresponding to the number labeled on the bag of every part. Some parts may not have label, you can refer to the pictures on the package list.

2 Assemble the rods of a Y axis

Step1. Assemble the 2 threaded rods.



Required parts	Required quantity	Part ID	Picture
φ10 threaded rod	2	NO.5	
Y plate connecting plate	2	NO.W14	
Spring washer	6	NO.17	
M10 Washer	8	NO.8	
M10 Nut	8	NO.12	

Thread the nuts and washers into the two M10 threaded rods separately. The order should be:

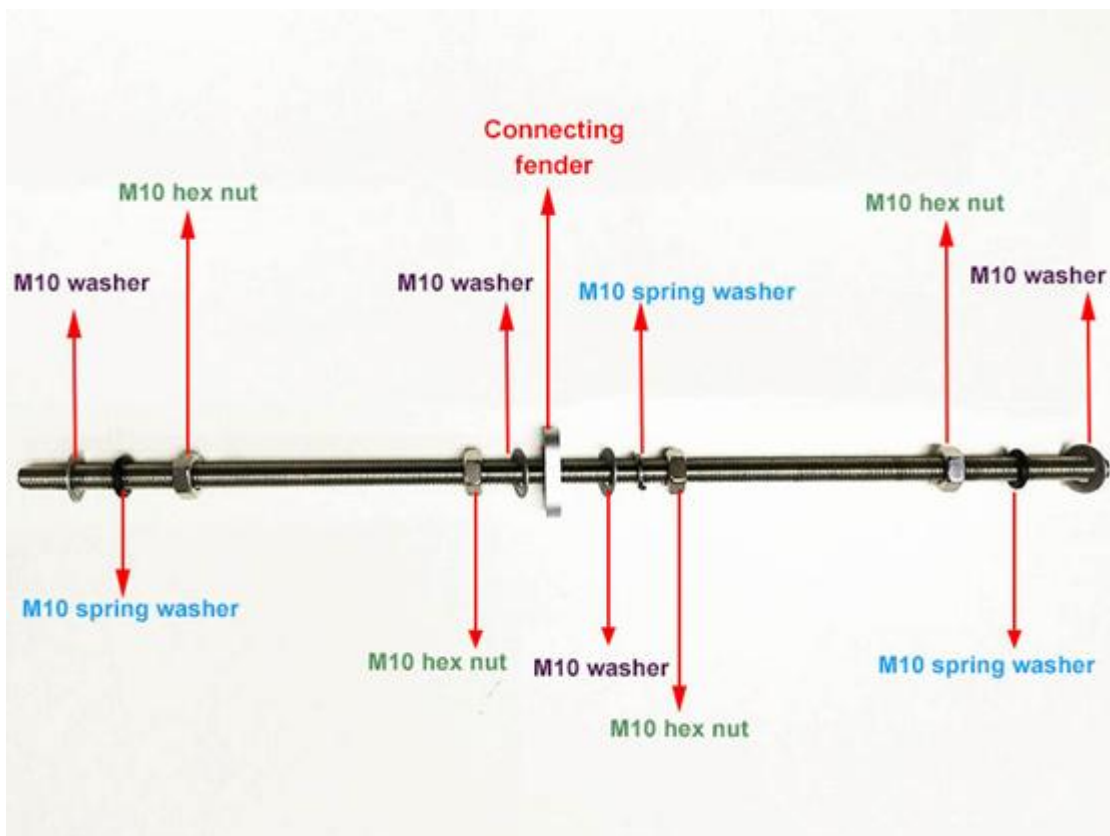
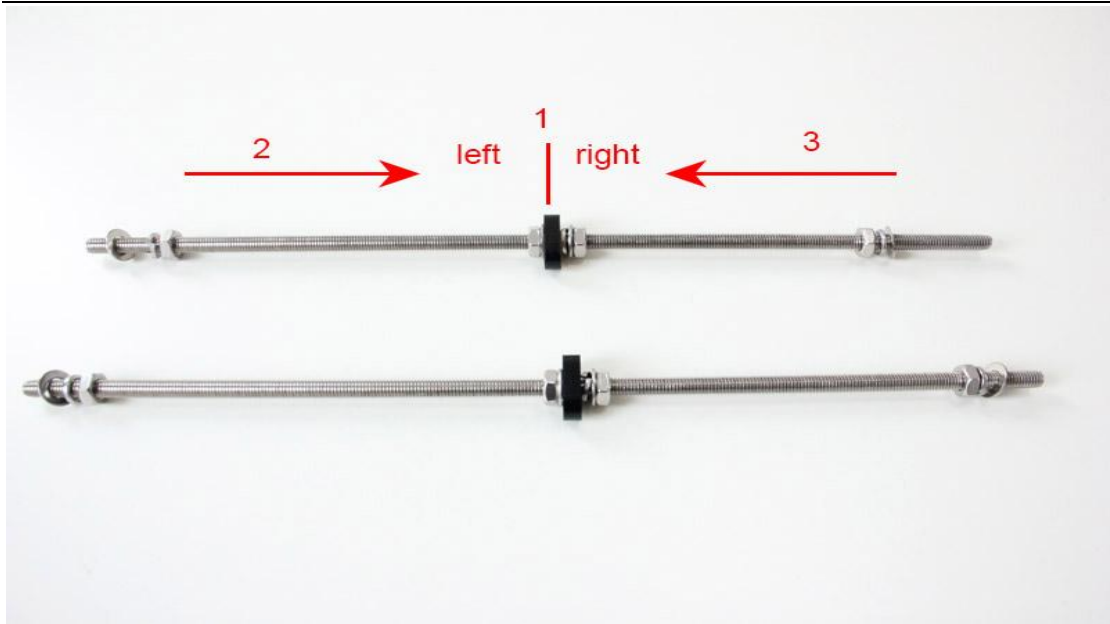
- 1) Thread the Y plate connecting plate W14 in the middle.
- 2) Thread the M10 washer > M10 spring washer > M10 nut > M10 nut > M10 washer on the left
- 3) (right) Thread the M10 washer < M10 spring washer < M10 nut < M10 nut < M10 spring washer < M10 washer on the right



Step2. Assemble the 2 smooth rods

Required parts	Required quantity	Part ID	Picture
φ8 smooth rod	2	NO.3	
LM8UU Linear bearings	3	NO.32	
Screw locking ring	2	NO.18	

①Take out the 410mm smooth rod





Slide 3 Linear bearings on each smooth rod, one smooth rod is slided the two pcs and another one is slided one. Before you slide the bearings please make sure they are clean.



② Slide the screw locking ring on the end of the smooth rod.



3 Assemble Y axis support plates

Required parts	Required quantity	Part ID	Picture
Support plate of Y axis(front)	2	NO. W9、 W 10	
Support plate of Y axis(rear)	2	NO. W 11、 W 12	
M10 washer	4	NO.8	
M10 nut	4	NO.12	

Step 1. Insert 2 threaded rods into rear support plates separately,then align to the

lower mounting hole;please note the sequential order of two support plates.(As below picture)

Step 2.Slightly fix the threaded rods and the rear support plate by M10 nut and M10 washer.

Step 3..Insert the end of which slides the lock ring on the smooth rods into the rear support plates,align to the lower mounting hole.Then slightly fix the lock ring.

Step 4.Separately insert the another end of the smooth rods and the threaded rods into the upper and the lower of the mounting holes.

Step5. Slightly fix the threaded rods and the wood plate by M10 nut and M10 washer.

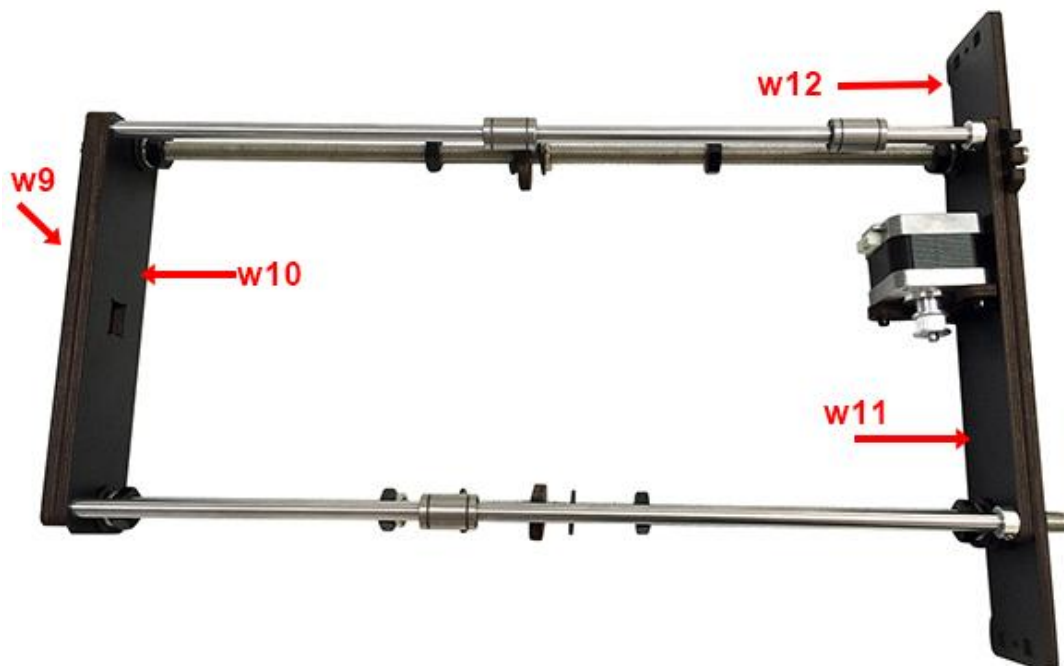

* Tips: Try to keep the thread rods parallel and the four wood pieces parallel. The Y-axis must be a rectangle, that is the rods on both side should be parallel, so is the front and back plate. Otherwise it will cause obstruction for the belt later. You can use a Digital Caliper to measure.

4 Mount the Y Motor

Required parts	Required quantity	Part ID	Picture
Y motor fix plate	1	NO. W13	
Stepper motor	1	NO.58	
Pulleys	1	NO.39	
M3 x 10mm screw	3	NO.22	
M3 x 16 mm screw	2	NO.24	
M3 square nut	2	NO.15	

M3 washer	5	NO.7	
-----------	---	------	---

Step1. Mount the pulley on the motor shaft, one of the screws should be screwed on the flat side of the shaft. Screw it as tight as possible.

(Note the direction of the pulley as below picture)

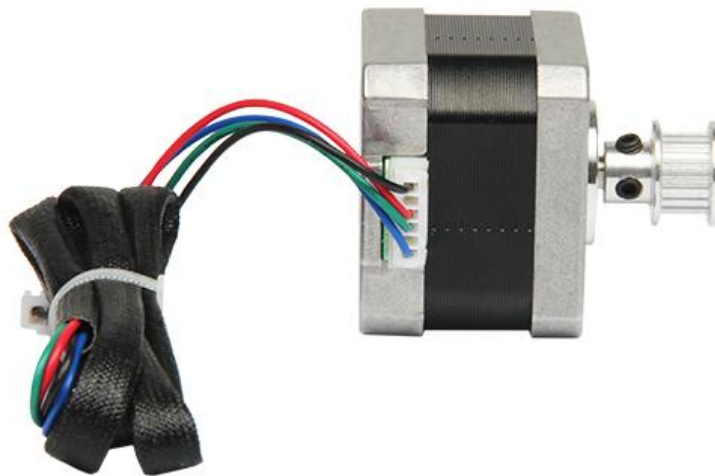

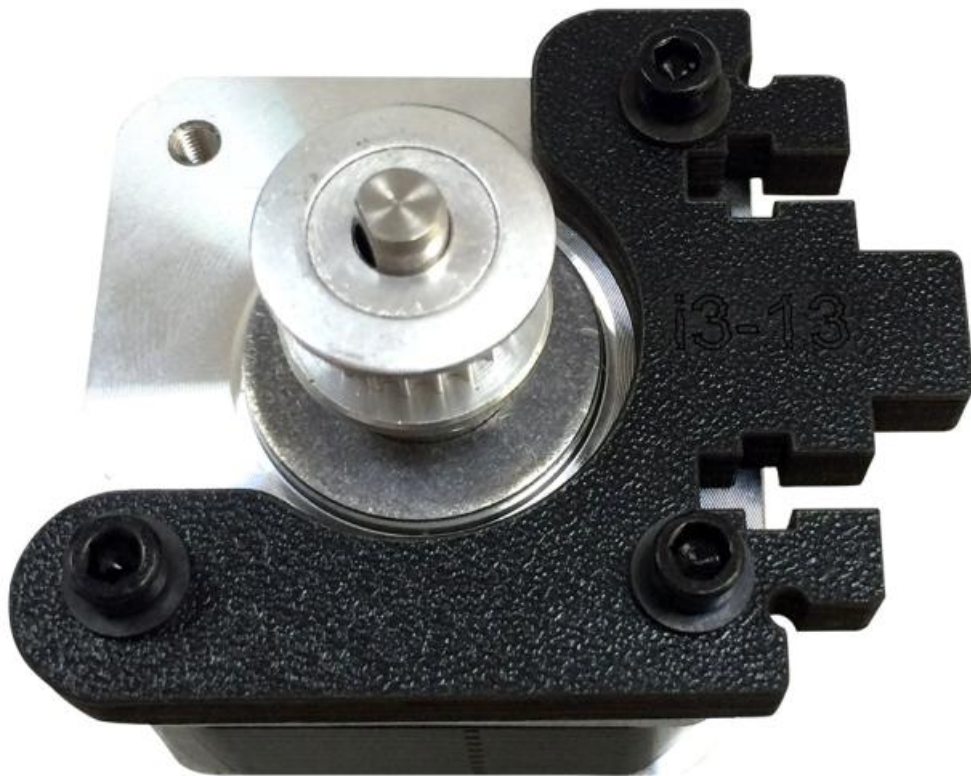

Step2. Then screw the motor on the Y motor holder with 3 M3 x 10mm screws and M3 washers.

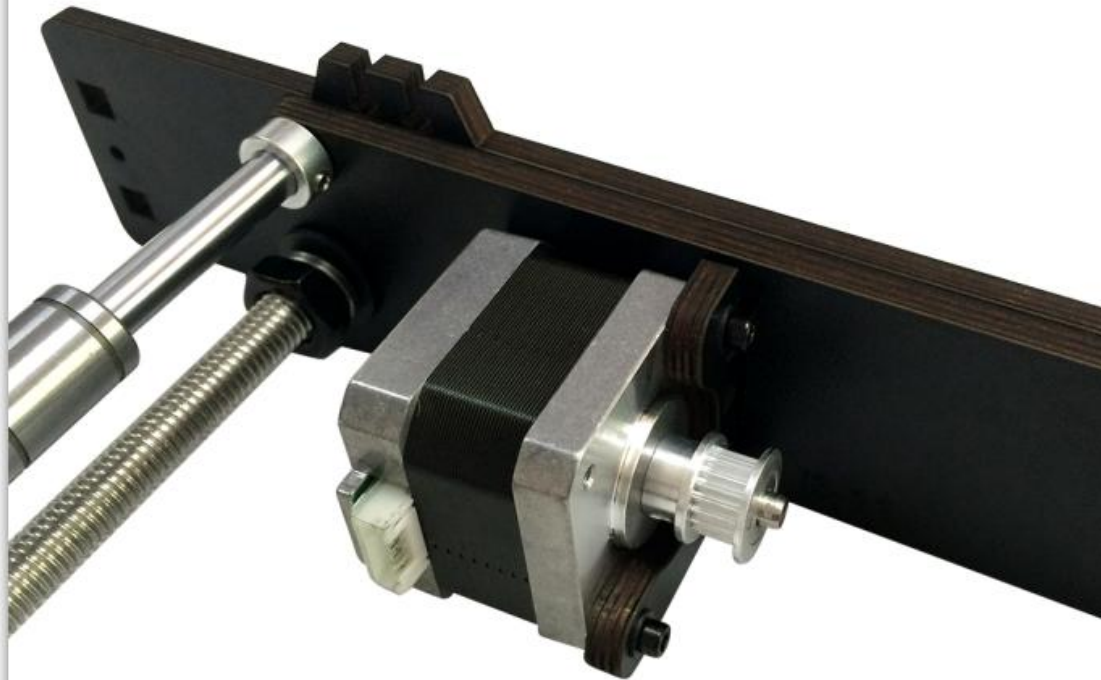

Step3. Push the Y Motor holder tab into the square hole in Rear -Outside Plate and Rear - Inside Plate. Then fix it with 2 M3x16mm screws, M3 Washers and M3 Square Nuts.



5 Build the printing platform

Required parts	Required quantity	Part ID	Picture
Y platform support	1	NO.W15	
Y bearing block	3	NO.W16	

Belt mount	1	NO.A17	
Belt bracket	1	NO.47	
Zip ties	4	NO.62	
M3 x 12 mm screw	3	NO.23	
M3 x 16 mm screw	6	NO.24	
M3 nut	8	NO.10	
M3 square nut	1	NO.15	
M3 washer	9	NO.7	

Step 1. Separately mount the 3 bearing blocks on the platform support plate with M3 x 16mm screws and M3 washer, then fix the other ends with M3 nuts.

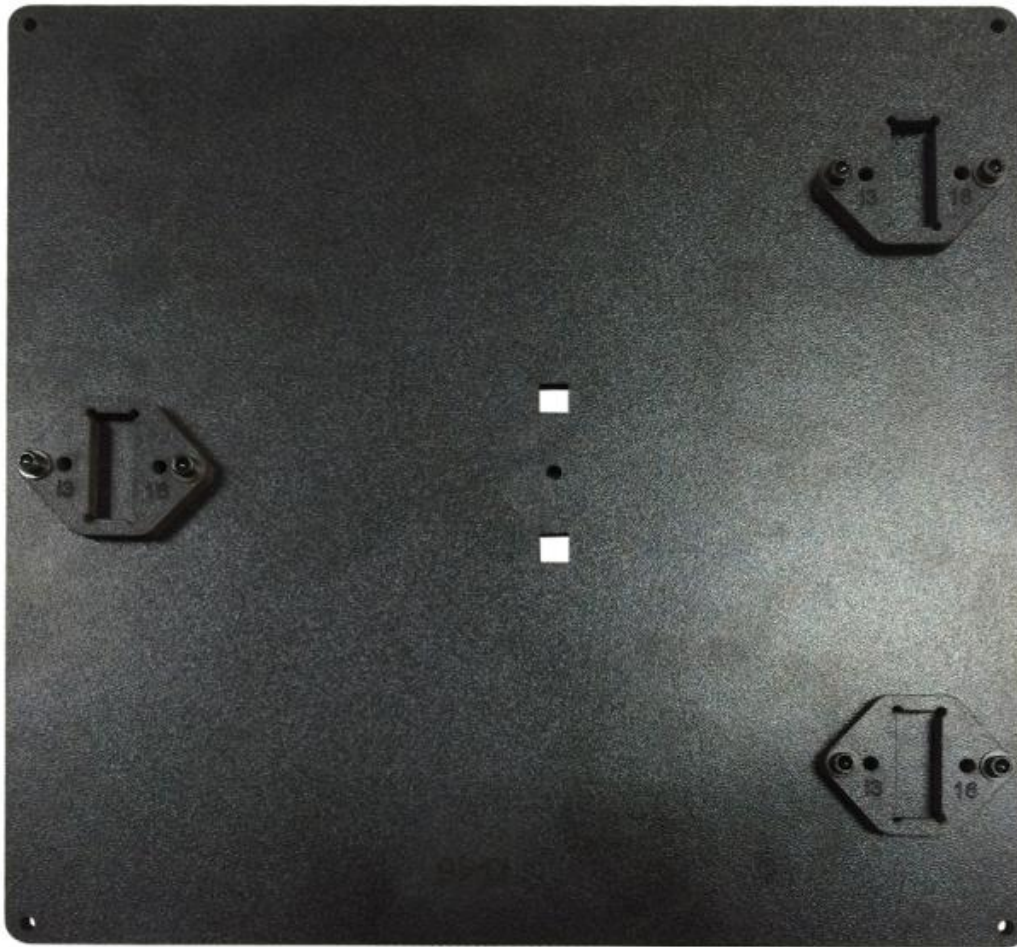

Step 2.Install the belt bracket on the belt-mount with 2 M3 x 12mm screws, M3 washer and M3 square nut.



Step3. Install the belt mount on the platform support plate with M3 x 12mm screw, M3 washer and M3 square nut on the same side with the bearing block.

(Note the direction: The direction of the belt brackt is same as the bearing block)







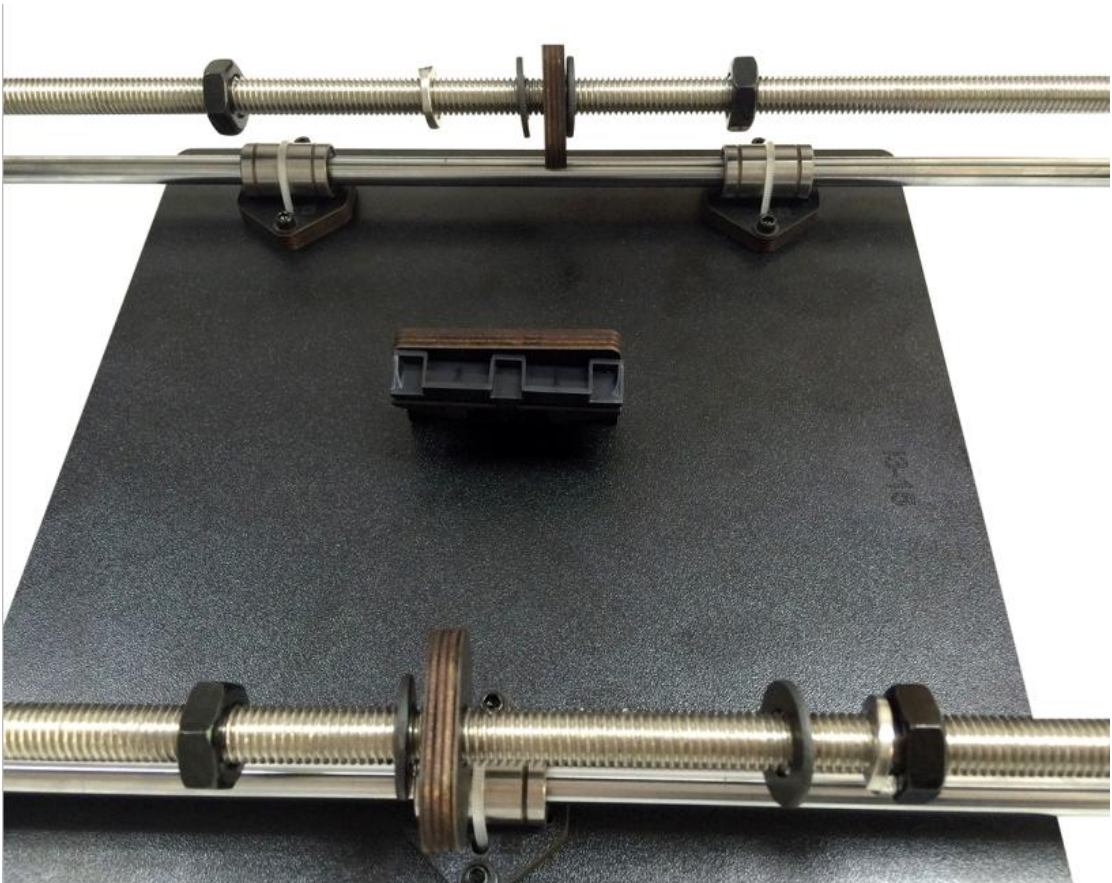
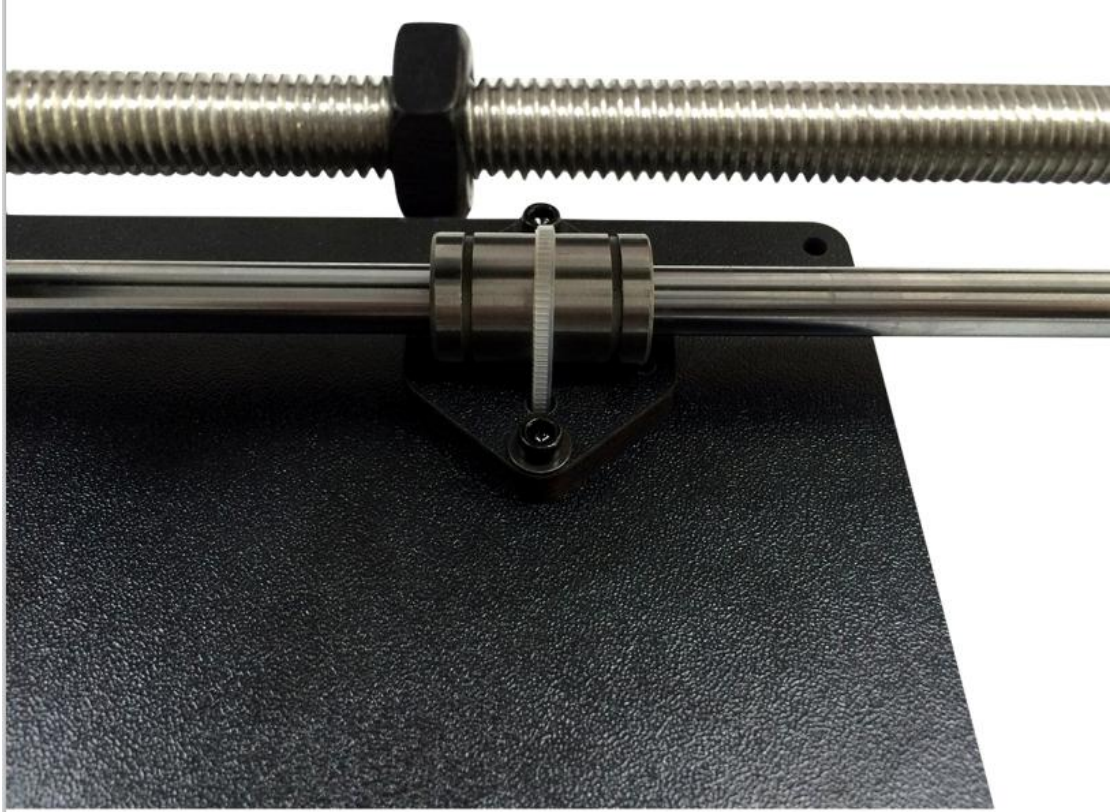

Step 4.Put the build platform support on the Y- Axis holder, and then get it zip-tied to the 3 linear bearings of Y- Axis together.

(Note the direction: The belt bracket is in the line with the pulley of Y motor.)



6 Assemble the Y idler

Required parts	Required quantity	Part ID	Picture
Ball bearing	2	NO.41	
Driven wheel holder	1	NO.37	
Driven wheel	1	NO.40	
M3 x 16 mm screw	1	NO.24	
M3 wing nut	1	NO.14	
M4 x25 mm screw	1	NO.29	
M4 Lock nut	1	NO.13	

Step1. Thread the M3 x 16mm screw through the driven wheel holder.

Step2. Put the driven wheel with ball bearing on the middle of the driven wheel holder; take the M4 x25mm screw through the driving wheel. Lock the other end with a M4 lock nut. You may need a pair of pliers to tighten locking nut.





**Do not screw it too tight, you should leave enough room for the wheel to turn freely.*

Step4. Mount the assembled bearing holder onto the front support plates from inside to outside. And screw it with a wing nut.

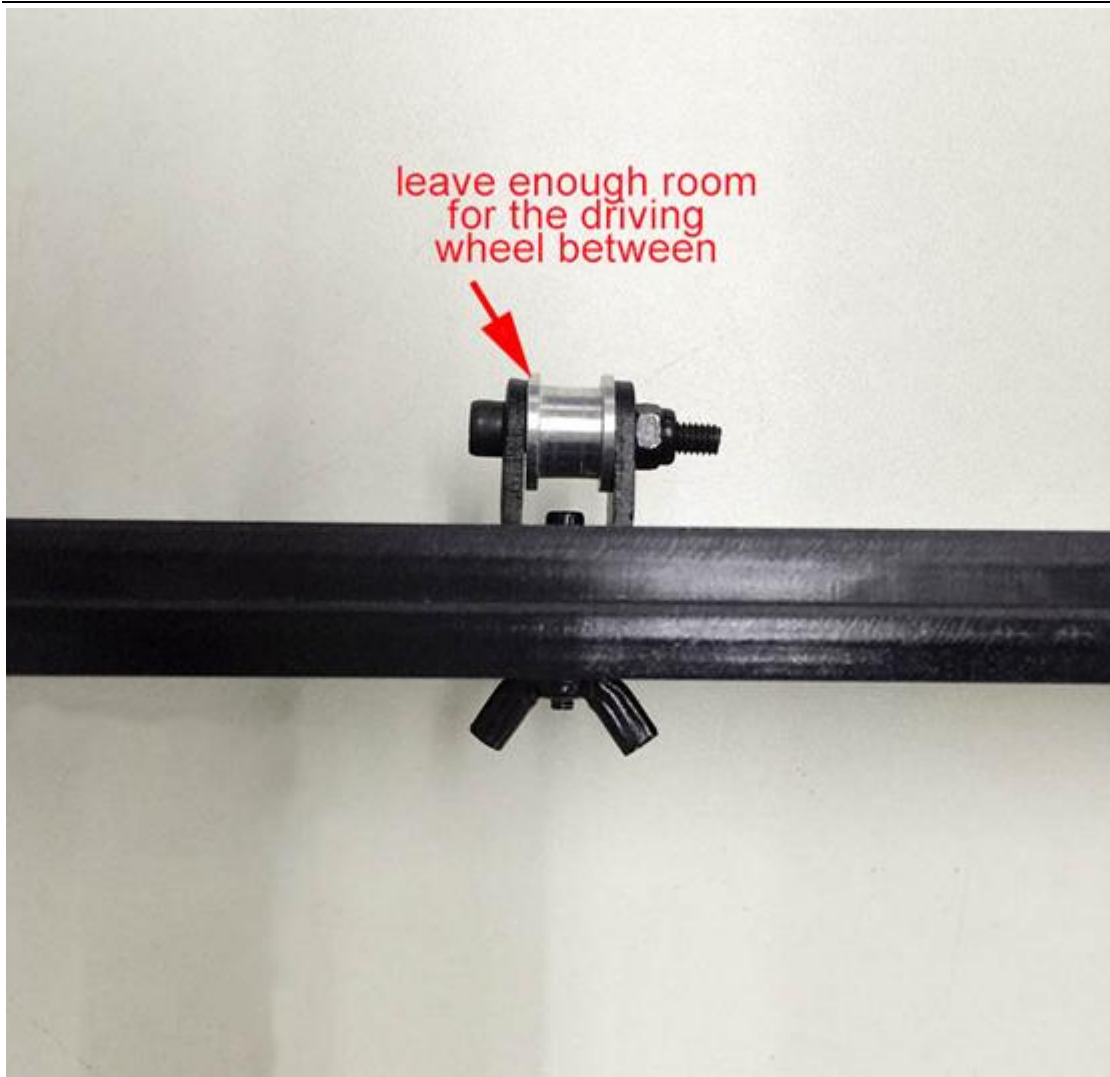

7 Mount the Y –axis belt

Required parts	Required quantity	Part ID	Picture
Timing Belts	1	NO.35	

Step1. Insert one end of the belt in the groove. Pay attention to the tooth mesh of the belt and the groove.

Step2. Thread the other end of the belt though the pulley of the Y motor.

Step3. Thread the belt though the driven wheel,then thread the M3 x 16 mm screw of the driven wheel though the front support plate of Y axis and lock it by the wing nut. Do not tighten too much at this step.

Step 4.Pull the belt into the groove of the belt bracket, tightly pull and confirm its length, then cut off the spare part.



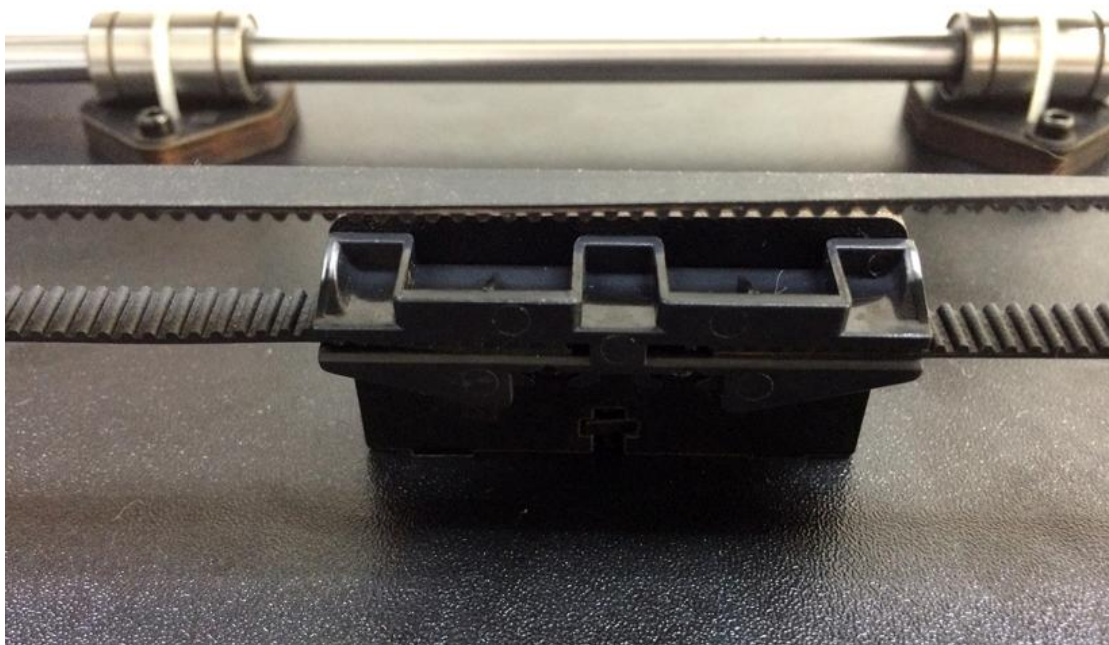

Step 5.Tight the wing nut.

Tips: The pulley, the belt bracket and the driven wheel must be in same level, and then ensure the printing platform can move smoothly.







8 Mount the End stop of Y-axis



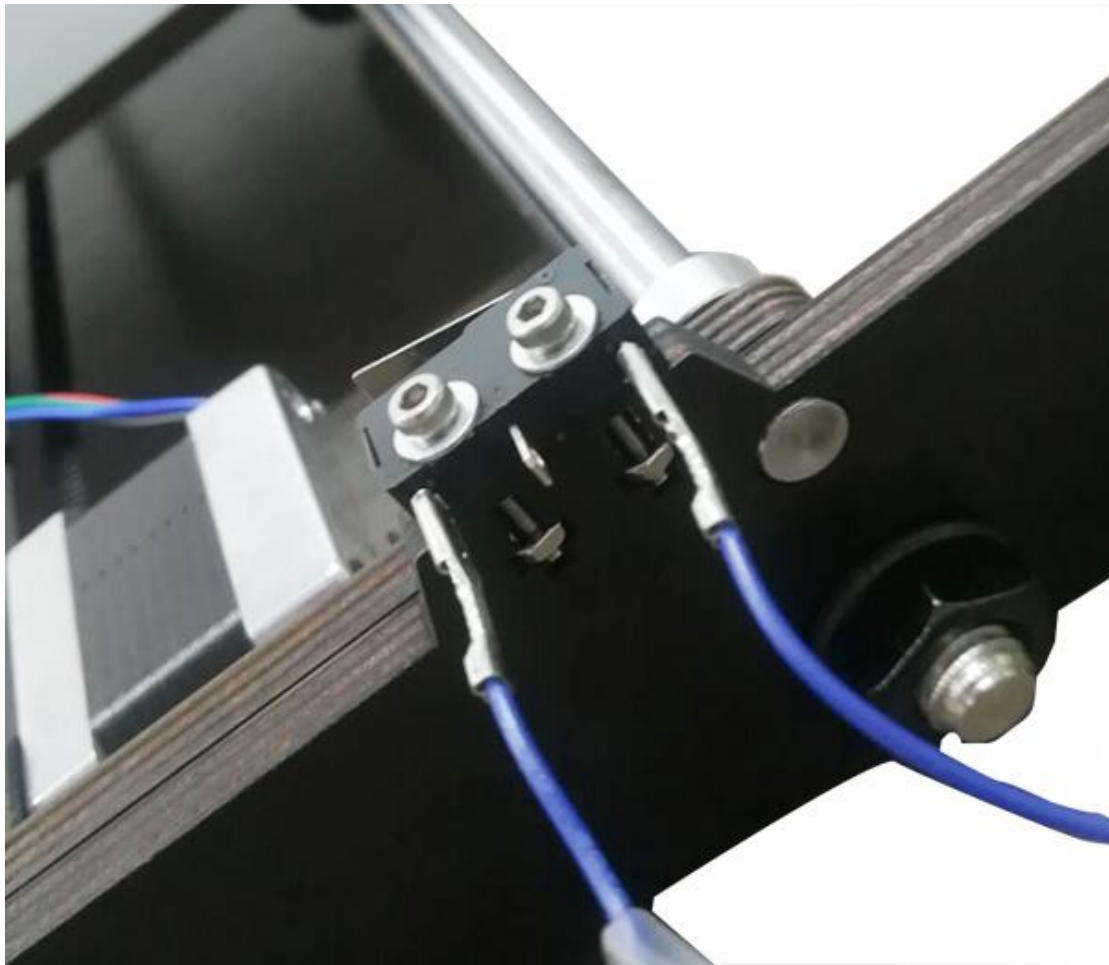



Required parts	Required quantity	Part ID	Picture
End stop	1	NO.52	
M2.5 x 16 mm screw	2	NO.20	
M2.5 square nut	2	NO.9	
M2.5 washer	2	NO.6	

Mount the end stop on the rear support plate of Y axis with M2.5 x 16mm screw, M2.5 washer and M2.5 Hex nut.



9 Assemble the XZ frame and the side panel

Required part	Required quantity	Part ID	Picture
X-Z frame (up)	1	NO. W1-A	

X-Z frame (bottom)	1	NO.W1-B	
Left side frame	1	NO.W2	
Right side frame	1	NO.W3	
M3 x 16 mm screw	6	NO.24	
M3 square nut	6	NO.15	
M3 washer	6	NO.7	

Step1. Screw up the X-Z frame (up) and the side panel with M3 x 16mm screws, M3 washer and M3 square nuts.













Step2. Screw up the X-Z frame (bottom) and the side panel with 2pcs M3 x 16mm screws; M3 washer and M3 square nuts.



10 Assemble the 2 Z motors support

Required parts	Required quantity	Part ID	Picture
Z motor fix plate (left)	1	NO.W4	
Z motor fix plate (right)	1	NO.W5	

Z motor support plate	3	NO.W6	
Z motor support plate	1	NO. W7	
M3 x 16 mm screw	10	NO.24	
M3 square nut	10	NO.15	
M3 washer	10	NO.7	

Step 1. Assemble Z motor support plate W6,W7 with Z motor fix plate (left) together with M3 x 16 mm screws, M3 washer and M3 square nuts.

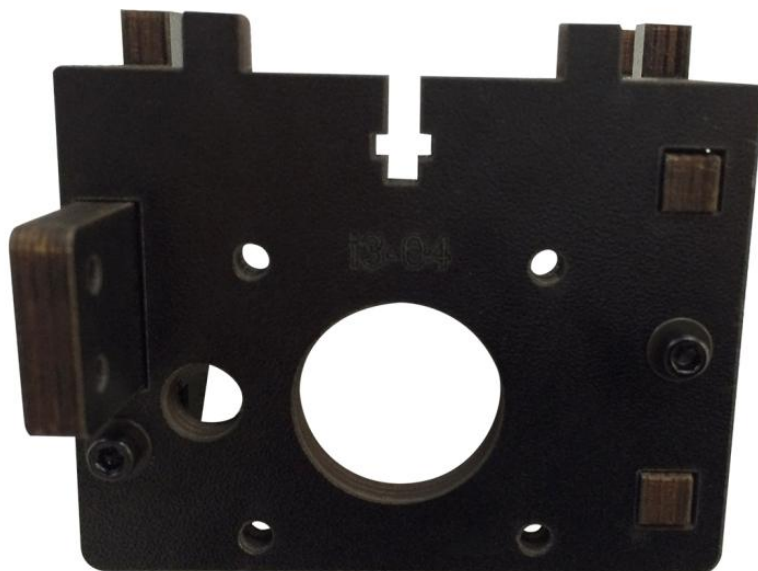



Step 2. Assemble 2 Z motor support plates W6 with Z motor fix plate (right) together with M3 x 16 mm screws, M3 washer and M3 square nuts.



Step 3. Separately screw up the assembled Z motor supports to the left and right corners of the main frame with M3 x 16mm screws and M3 square nuts.

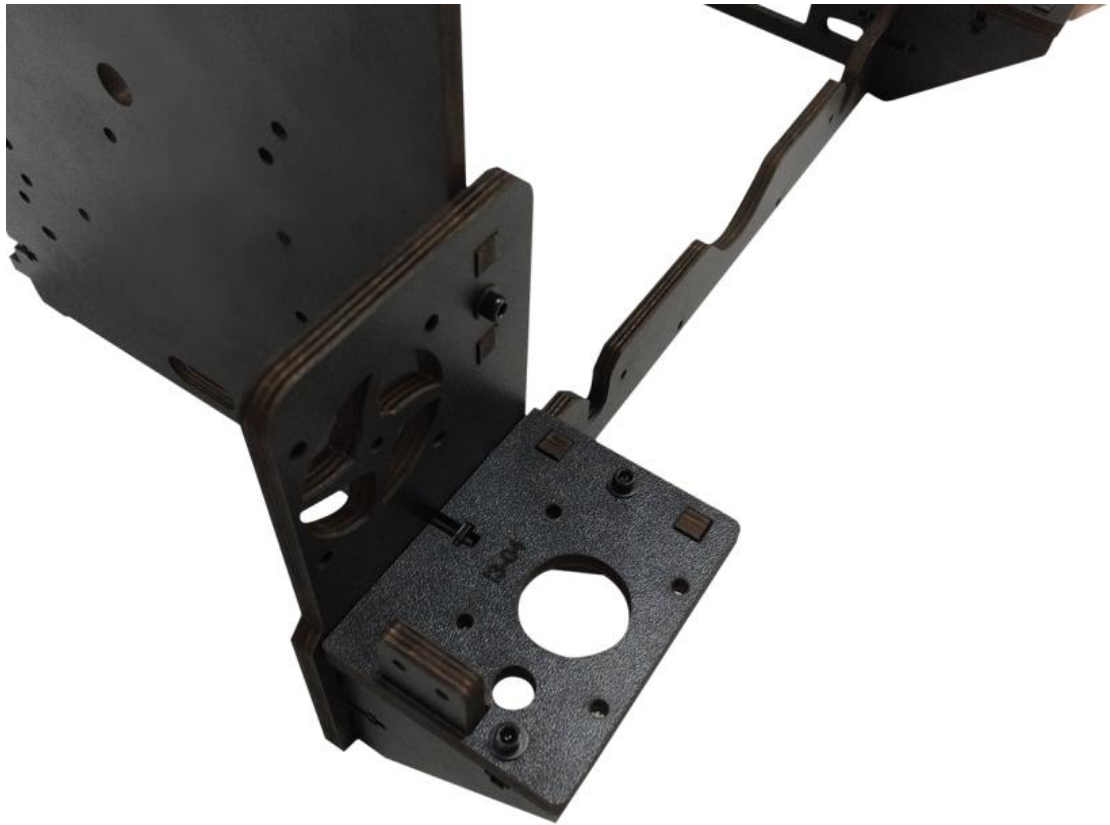





(Left)

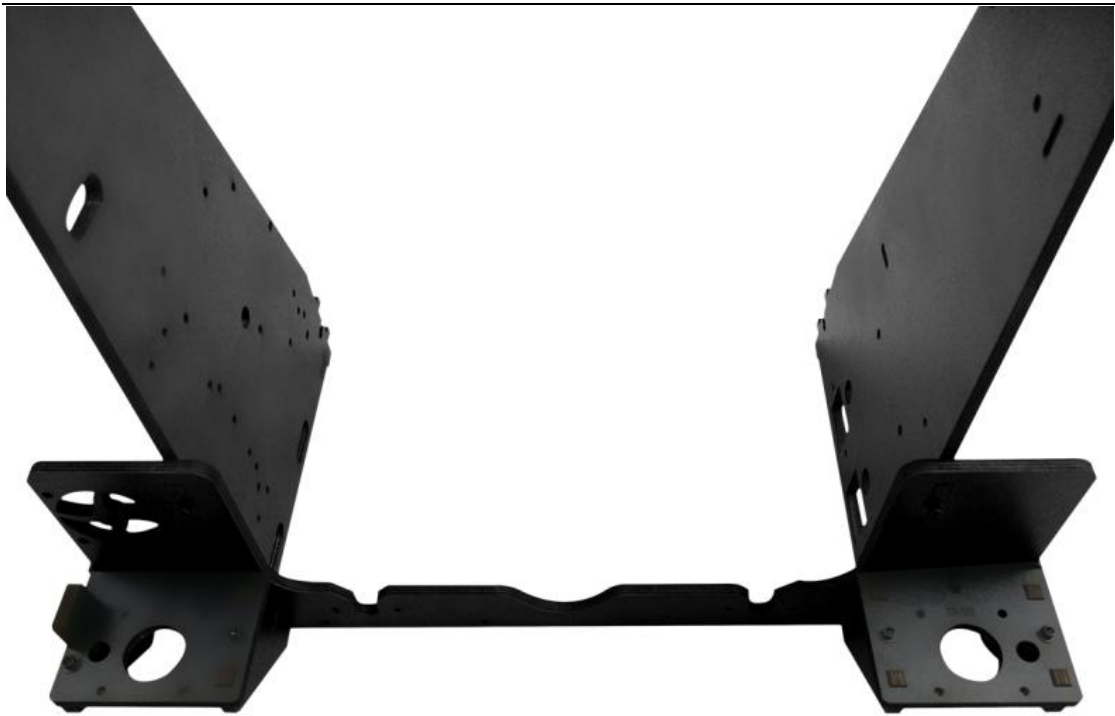

(Right)



11 Mount the fan

Required parts	Required quantity	Part ID	Picture
Fan	1	NO.49	
M3 x20 mm screw	4	NO.25	
M3 nut	4	NO.10	
M3 washer	4	NO.7	

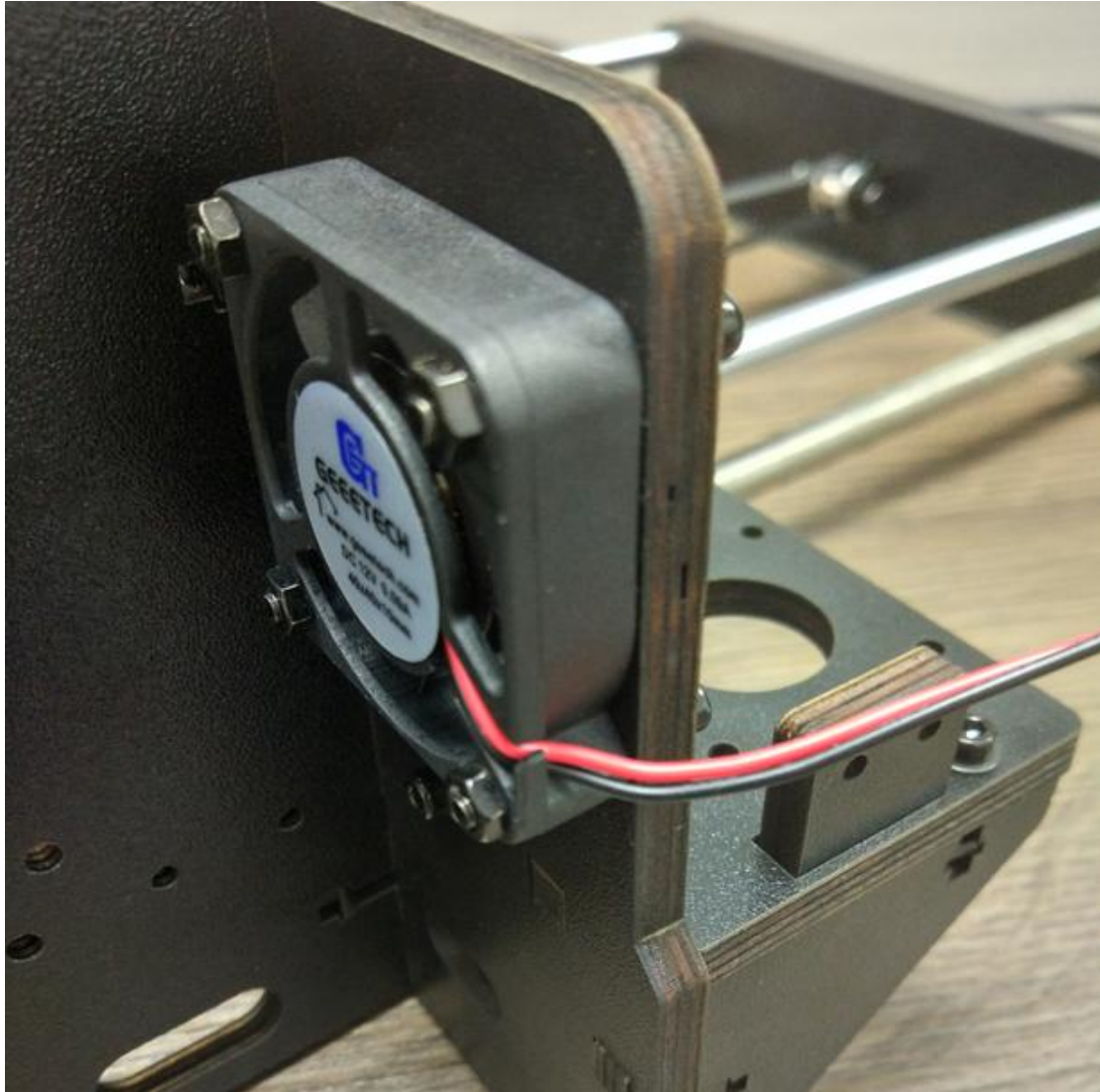

Fix the fan on the left side of the frame with 4 M3 x 30 screws, M3 washer and M3

nut. Mind the direction of the fan. (The side with the label is outward.)



12 Assemble Y - Z axis

Required parts	Required quantity	Part ID	Picture
M3 x 16 mm screw	6	NO.24	

M3 nut	4	NO.10	
M3 square nut	2	NO.15	
M3 washer	6	NO.7	

Step1. Put the Y axis between the main frame.







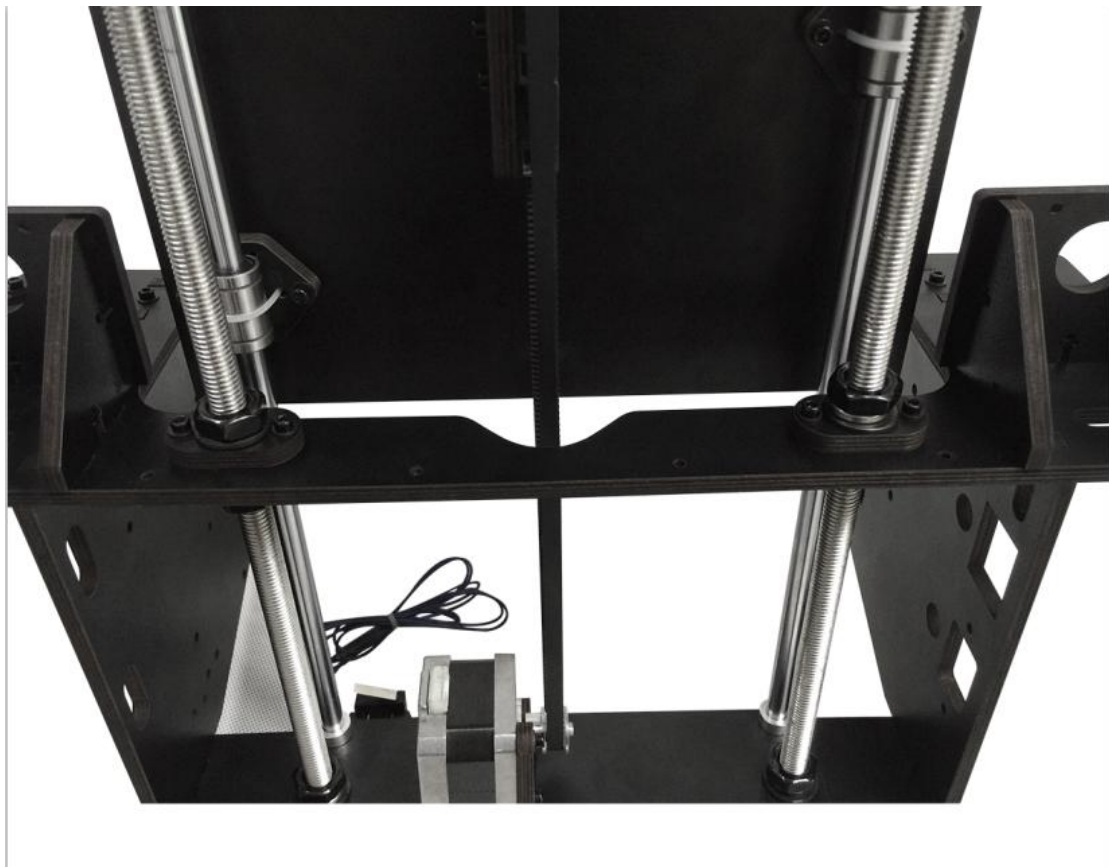

Step2. Screw up the main frame to the Y axis connect plate with 4 M3 x 16mm screws, M3 washer and M3 nuts. And screw up the M10 nuts.



Step3. Screw up the Y axis rear plate and the side panel with M3 x16mm screws,M3 washer and M3 square nuts.



13 Mount Z-axis End stop

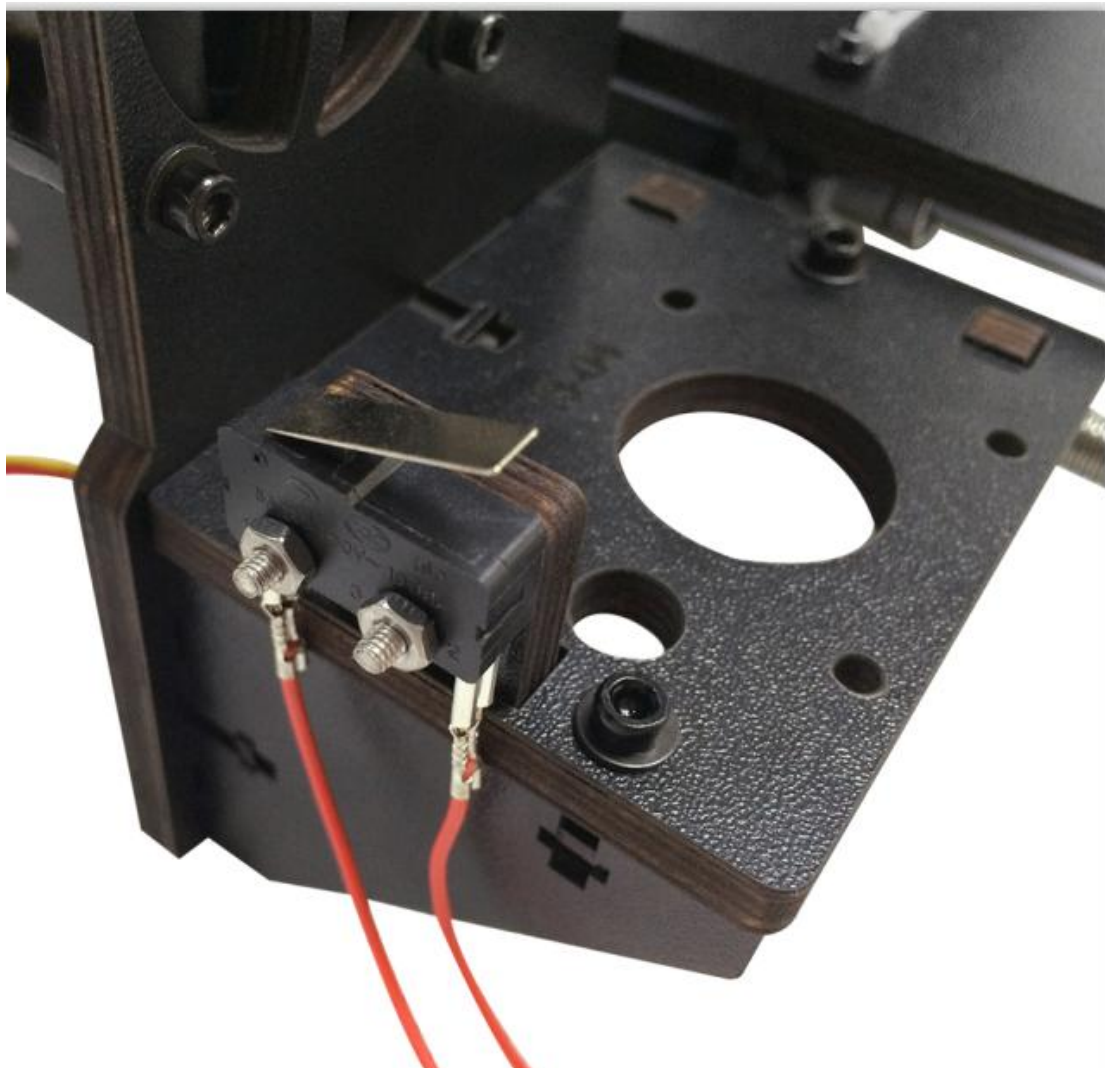

Required parts	Required quantity	Part ID	Picture
End stop	1	NO.52	
M 2.5 x 16 mm screw	2	NO.20	
M 2.5 nut	2	NO.9	
M 2.5 washer	2	NO.6	

Mount the endstop on the Z -axis motor base (left) with M2.5 x 16mm screw,M2.5 washer and M2.5 hex nut.



14 Mount the 2 Z motors

Required parts	Required quantity	Part ID	Picture
Stepper motor	2	NO.58	

M3 x 10mm screw	8	NO.22	
M3 washer	8	NO.7	

Step1.Thread the wires of the motors through the holes of the main fame.Then put the motor under the motor base.

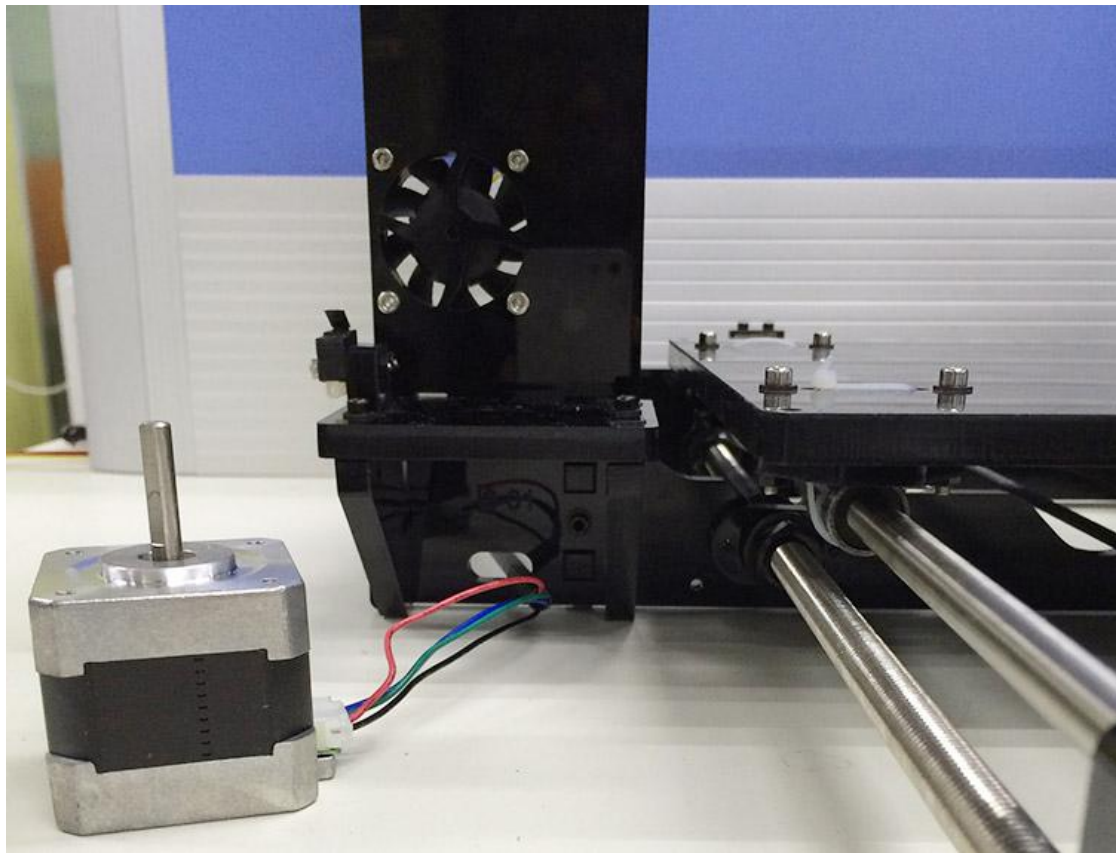

Step2. Screw up the motors with 4 M3 x 10mm screws and M3 washer.

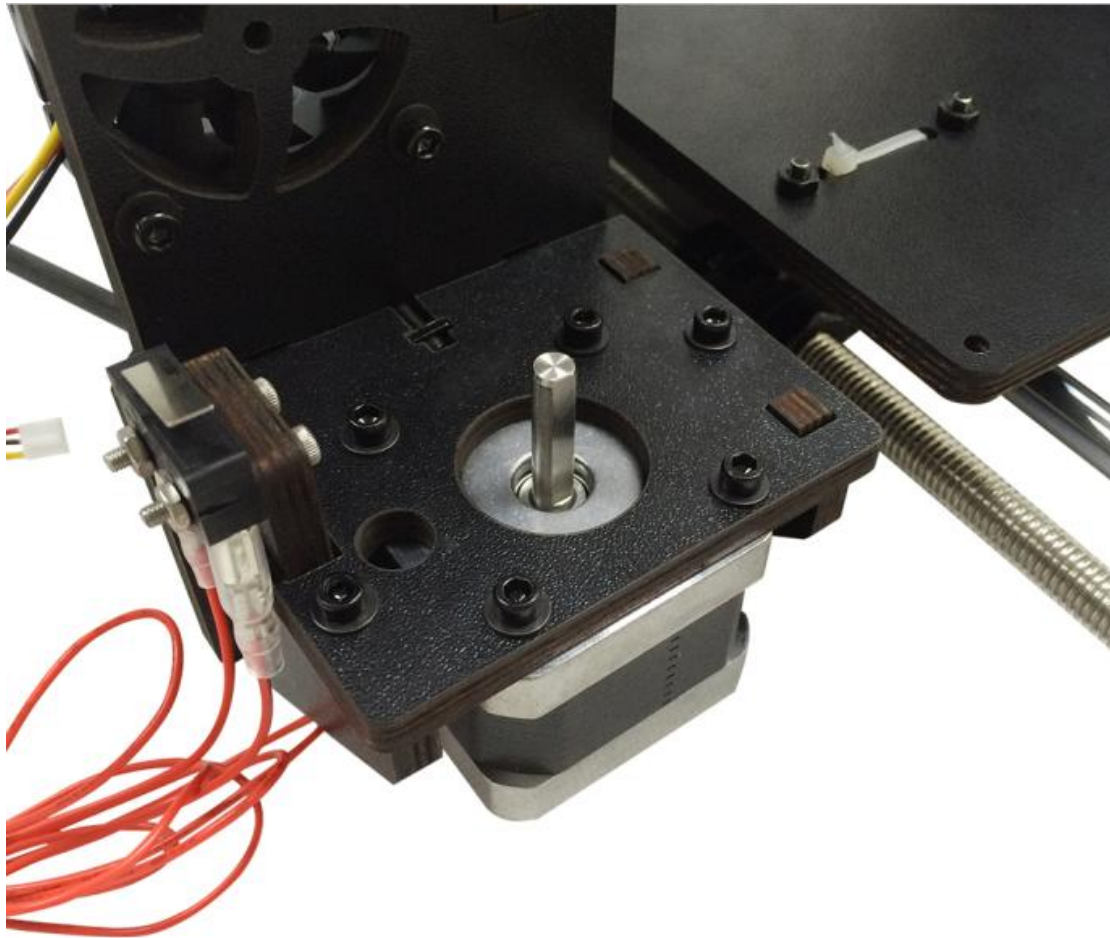

Do the same with the other Z motor according the above steps.

15 Mount the coupling

Required parts	Required quantity	Part ID	Picture
Coupling	2	NO.38	

Step1. Fix the two couplings on both of the motor shaft.

Please note:

1. The opening of both end, one is 5mm, another is 8mm, connect the 5mm hole to the motor shaft.
2. Screw the small bolt of the 5mm part on the **upper part of the flat side** of the motor shaft tightly.,you can see the boundary in the inner of the coupling.

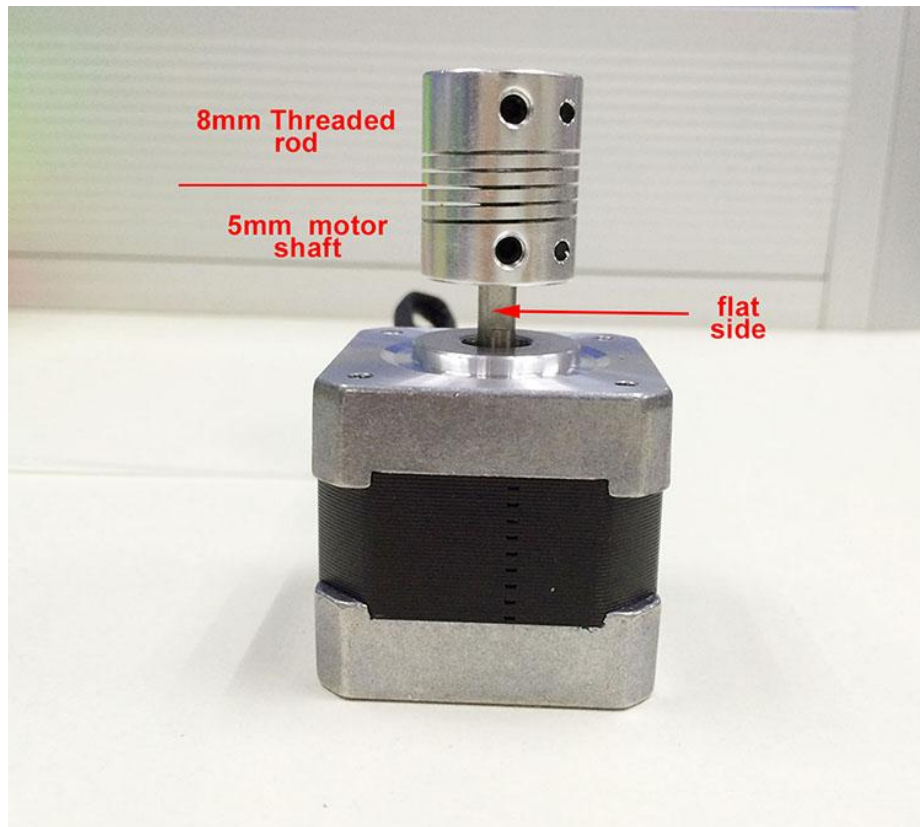

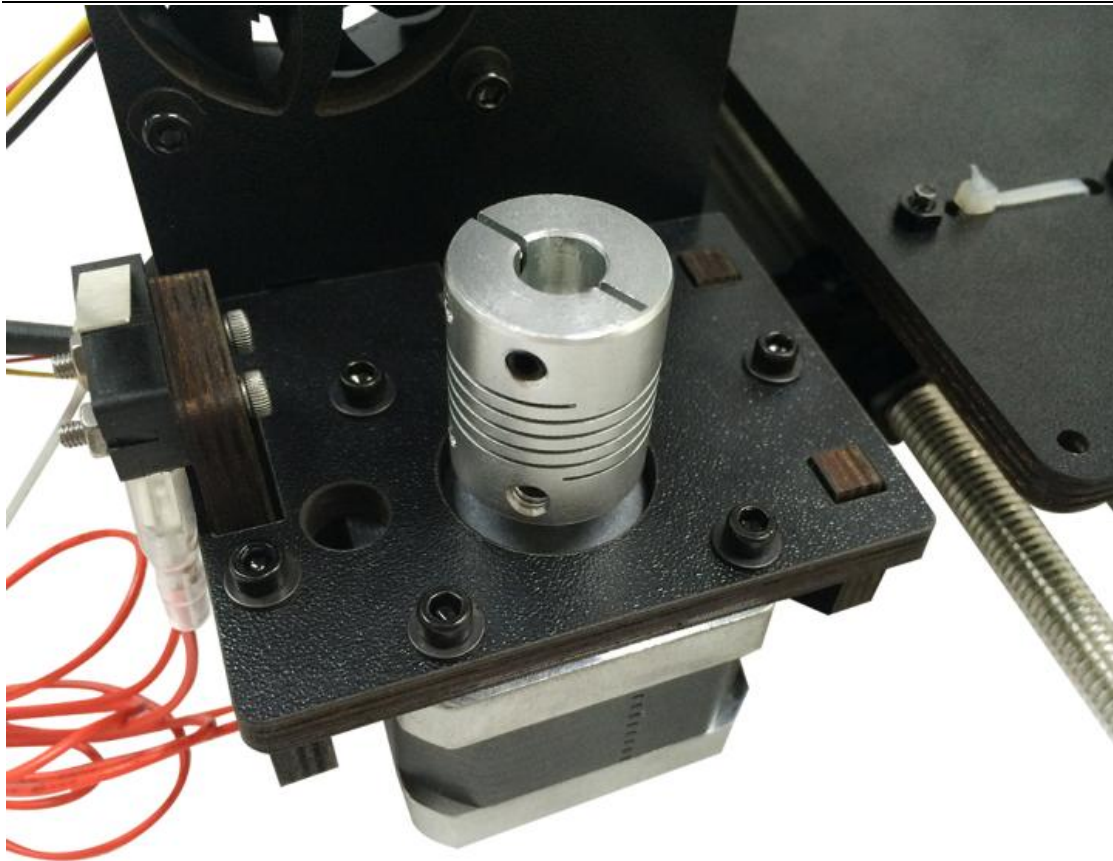





Do the same with the coupling of the right motor shaft according the above steps.



16 Assemble the X-axis motor end

16.1 Assemble the Linear bearing and Z axis nut

Required parts	Part ID	Required quantity	Picture
Z-axis nut	No.16	1	
X-axis left end	No.M1	1	
Linear Bearings	No. 34	1	
M3 x 6mm screw	No. 21	8	





Step1. Mount the Z nut on the X-axis left end from bottom to up, fix with M3 x 6mm screws.

Step2. Mount the linear bearing on X-axis motor end from bottom to up. Fix it up with M3 x 6mm screws.





16.2 Mount X-axis motor

Required parts	Part ID	Required quantity	Picture
Stepper motor	No.58	1	
Pulleys	No.39	1	
M3 x 6 mm screw	No. 21	3	
M3 washer	NO.7	3	

Step 1. Mount the pulley on the motor shaft and fix it from the flat side.





Note the direction of the pulley: the gear is at the bottom.

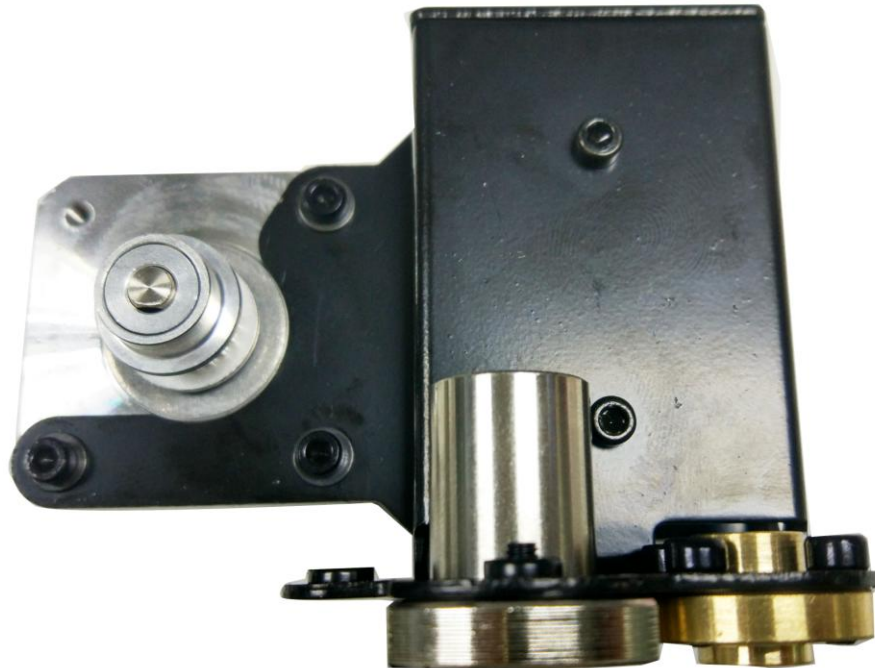

Step 2. Mount the stepper motor to the motor end with 3 M3x6mm screws and M3 washers.



16.3 Mount the end stop and the endstop trigger

Required parts	Part ID	Required quantity	Picture
M2.5 x 8 mm screw	No. 19	2	
End stop	No.52	1	
M3 x 35 mm screw	No. 26	1	
M3 washer	NO.7	3	

Spring	NO.31	1	
--------	-------	---	---



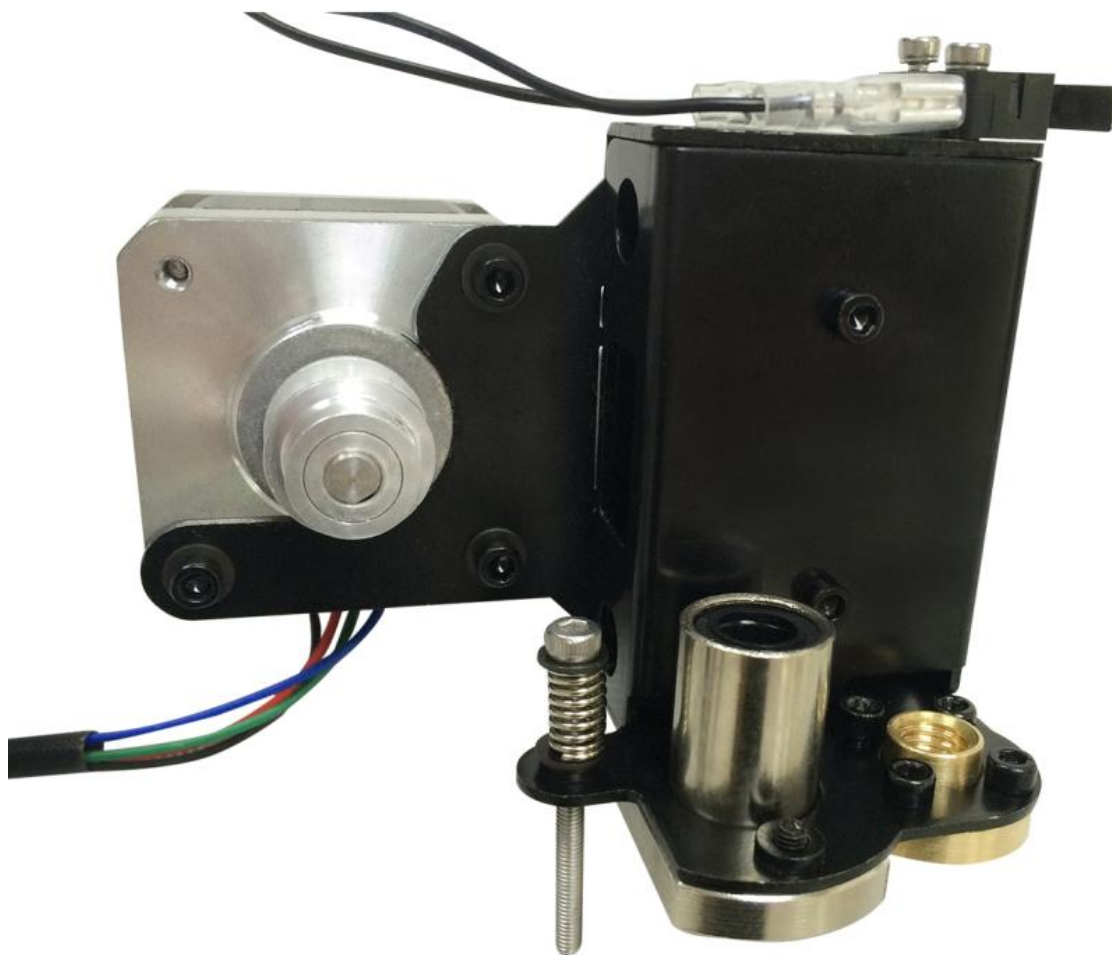

Step1. Mount the endstop on the top of the X-axis motor end with 2 M2.5 x 8mm screws. **Mind the direction of the endstop paddle.**

Step 2. Thread a M3 washer> spring> M3 washer in order to the M3x35mm screw.

Step 3. Thread the M3x35mm screw into the screw hole.



17 Assemble X axis idler end



Required parts	Part ID	Required quantity	Picture
Z-axis nut	No.16	1	
X axis right end	No.M2	1	
Linear Bearing LMH8LUU	No. 34	1	
M3 x 6mm screw	No. 21	8	

Step1. Mount the Z axis nut on the bottom of X-axis right end with 4 M3 x 6mm screws.

Step2. Mount the linear bearing on X-axis idler end from bottom to up. Fix it up with M3 x 6mm screws.



18 Assemble the extruder carriage

Required parts	Part ID	Required quantity	Picture
Bearing mount	No.M3	1	
Bearing Bracket	No.M4	4	

Extruder bracket	No.M5	1	
Linear Bearing LM8LUU	No.33	2	
Belt bracket	No.47	1	
M3x6mm screw	No. 21	8	
M4x6mm screw	No. 28	2	
M3 nut	No.10	2	

Step1. Fix the 4 Bearing Brackets on the back of the X Carriage loosely with M3x6mm screws.

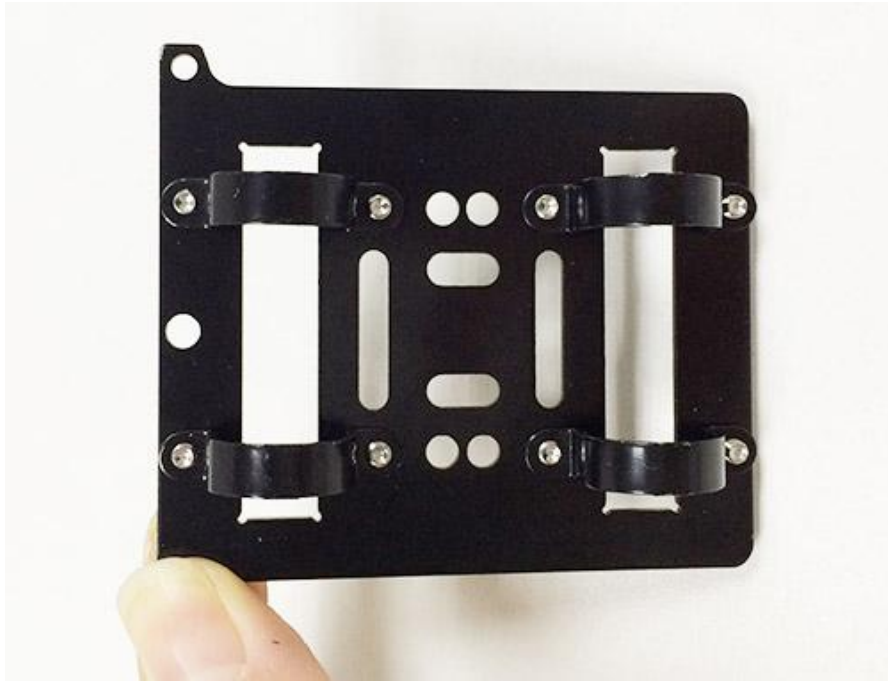

Step2. Insert the linear bearing into the bearing mount slot and tight the screw.

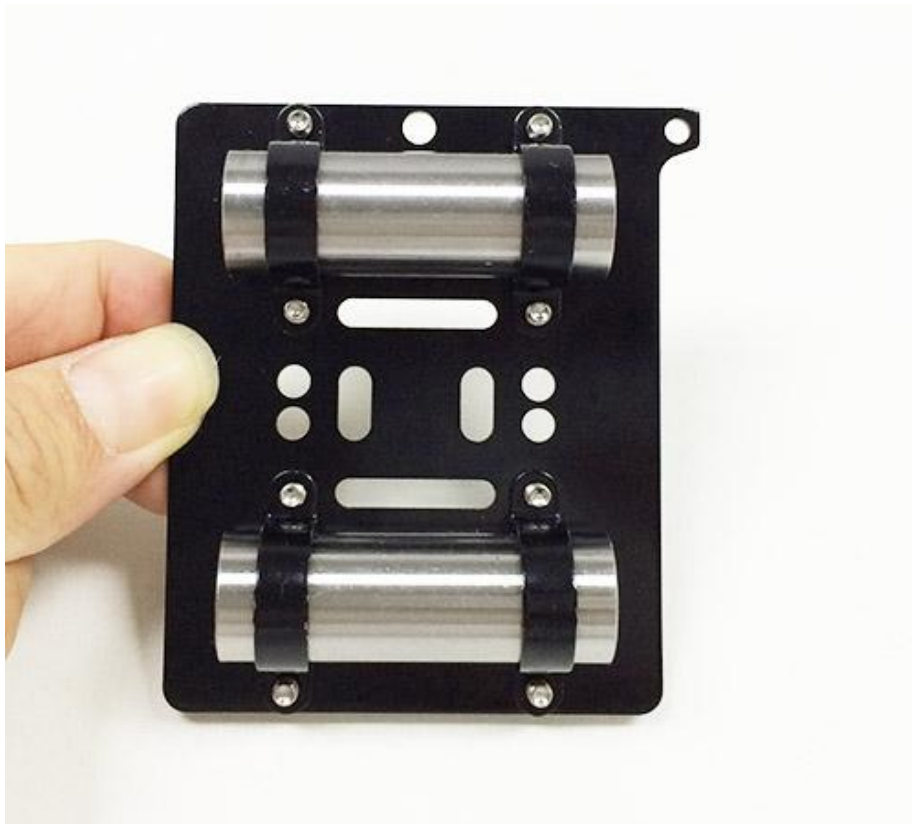

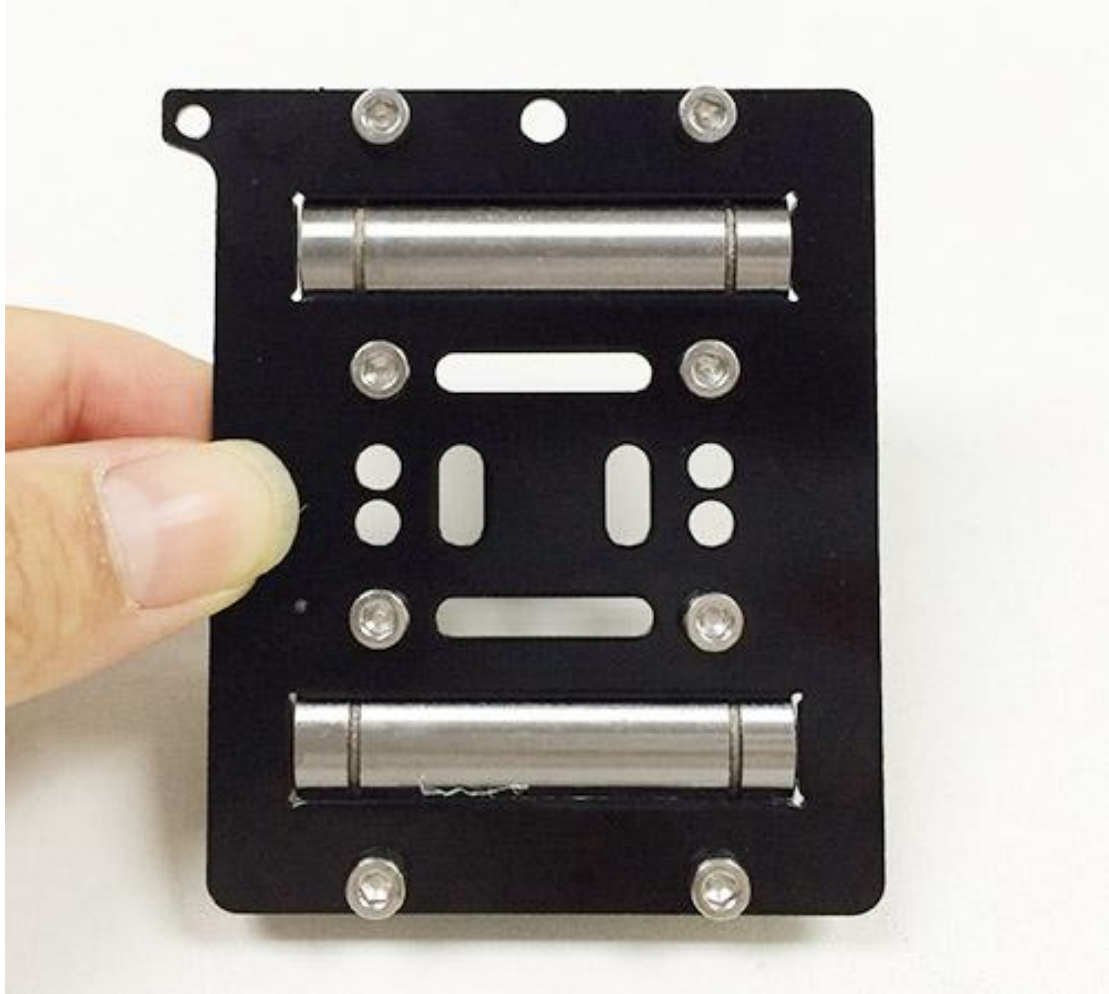

Step3. Fix the belt bracket on the back of the carriage with 2 M3 x6mm screws and M3 hex nuts.



Step3. Fix the extruder holder on the front side of the X carriage with M4x6mm screws.



19 Assemble the X&Z axis

Required part	Part ID	Required number	Picture
L300mm Threaded rod	No.4	2	
L322mm Smooth rod	No.1	2	
L390mm Smooth rod	No.2	2	

Screw locking ring	No.18	4	
--------------------	-------	---	---

Step1. Use the file to polish the holes on the X axis motor end and the idle end to make sure the L390mm Smooth rod can thread in to them smoothly. (8 holes in total)

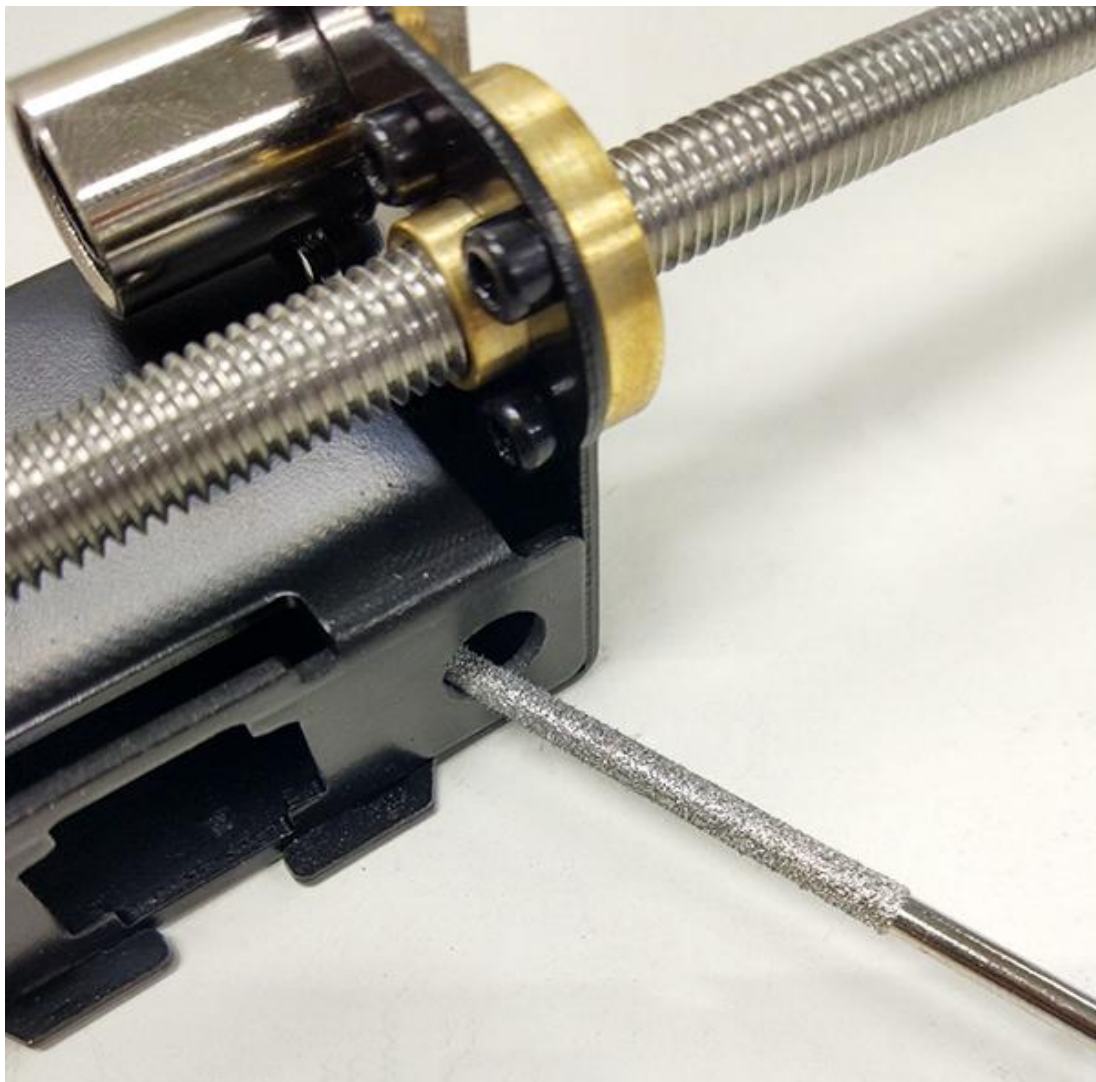

Step2. Thread the L300 threaded rod to the nut of both end of X axis.

Keep both end of X axis at the same place of the rod, you are advised to measure the distance of the both side so that they are at the same level when you put them up.

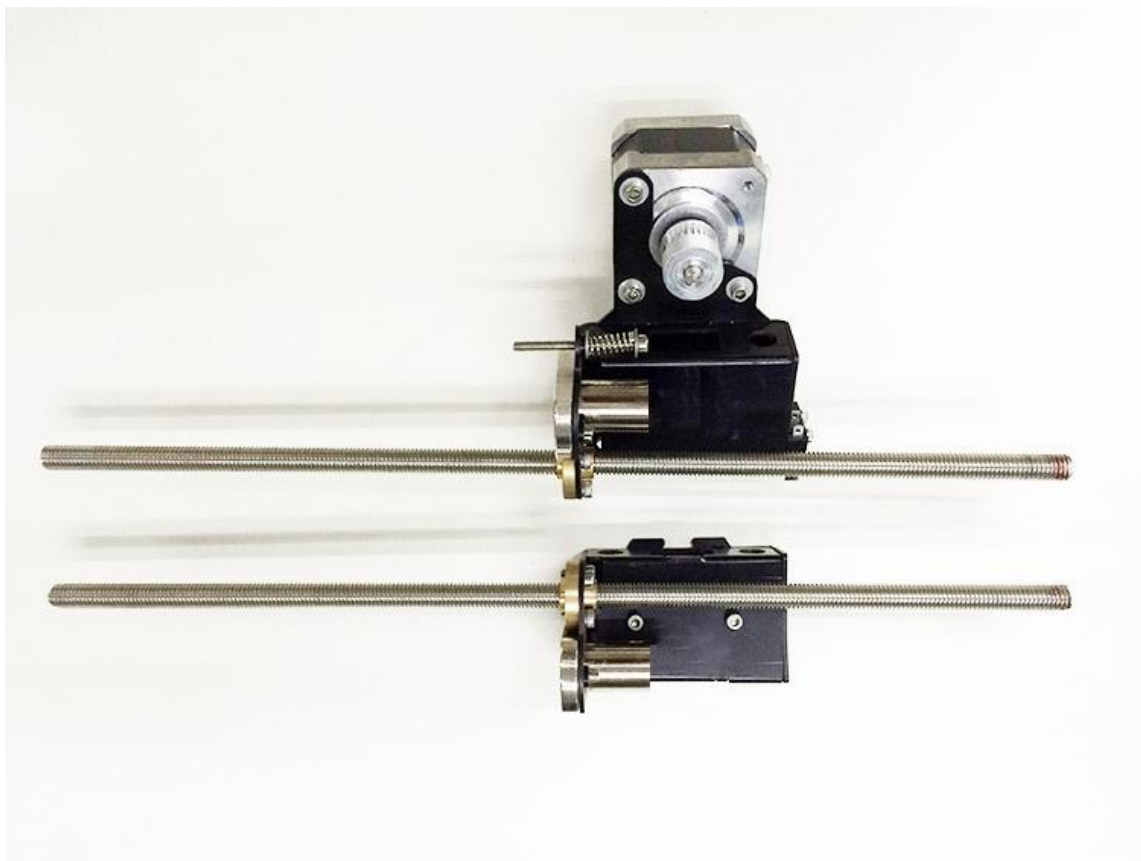

Step3. Plug the threaded rod on the X motor end to the left coupling on the left motor of the Z axis. Then thread the 320mm smooth rod into the linear bearing.

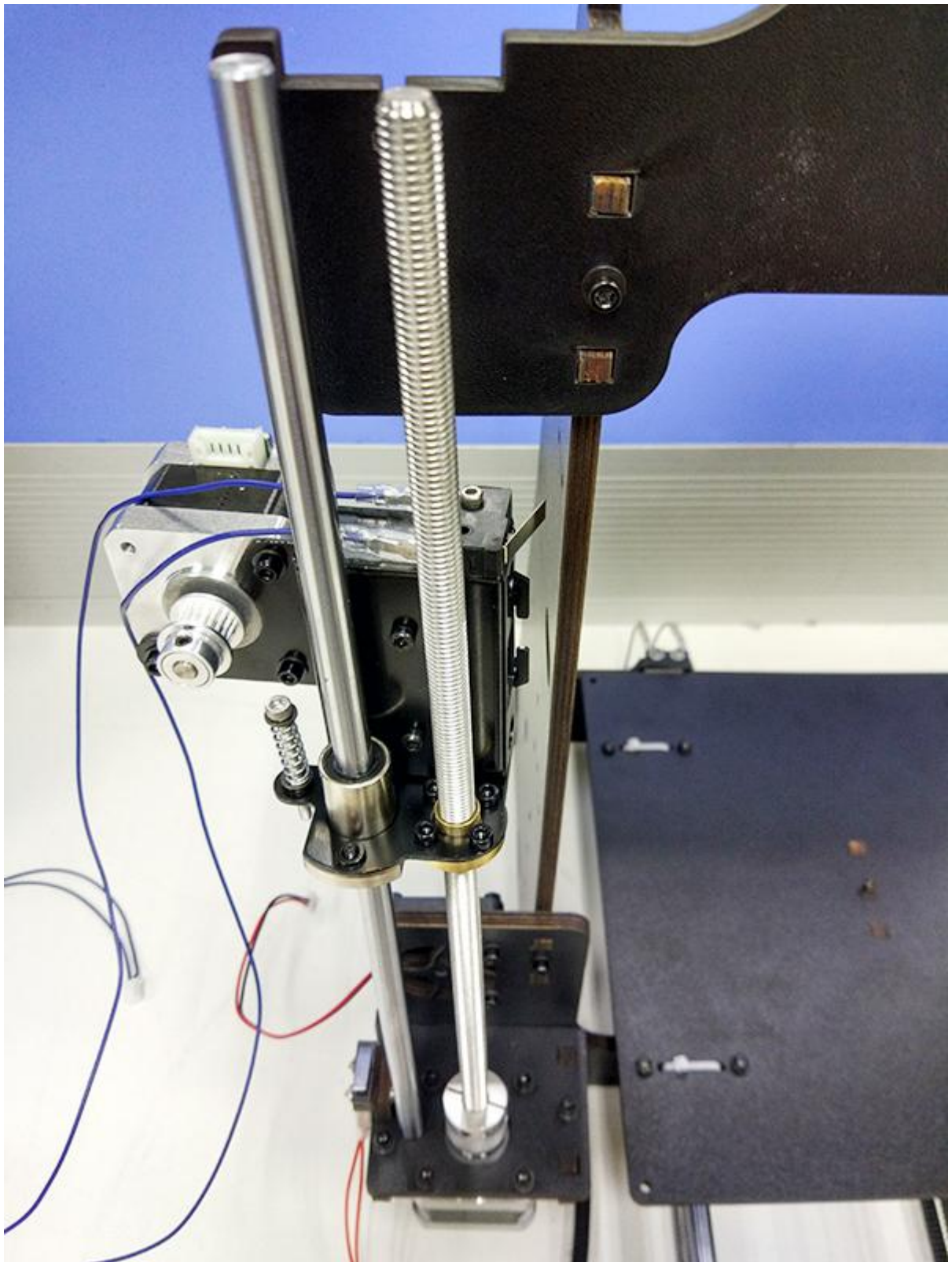

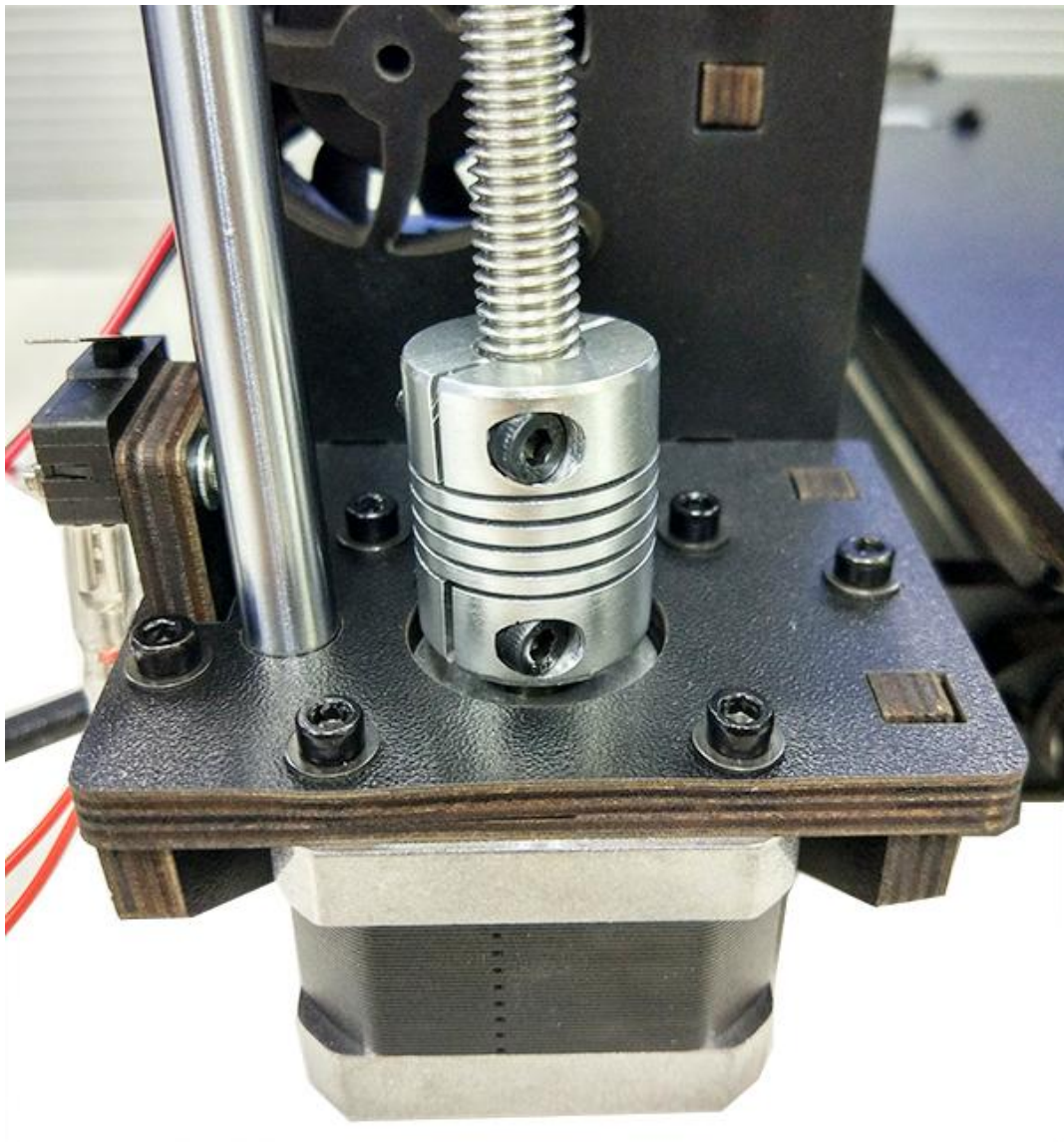

Step4. Thread the L390mm smooth rod into the X motor end > thread the extruder carriage on the two rods.

Step5. Thread the two X axis smooth rods into the hole of X idler end.







Step6. Plug the vertical threaded rod into the coupling on the right motor of the Z axis.
Then thread the 320mm smooth rod into the linear bearing.



20 Assemble the Z axis top mount

Required part	Part ID	Required number	Picture
---------------	---------	-----------------	---------

Z axis top mount	No.W8	2	
M3 x 16mm screw	No.24	4	
M3 square nut	No.15	4	
Screw locking ring	No.18	2	
M3 washer	No. 7	6	

Step1. Put the locking ring on the two smooth rods separately.

Step2. Add the Z top mount (No.W8) to the top of W1. Slowly rotate the rods into the holes, or add some lubricants on the rods.

Step3. Screw up the top mount,the main frame and the side panel with M3 x 16mm screw and M3 Square nut.

Step4. Screw up the locking ring on smooth rods.

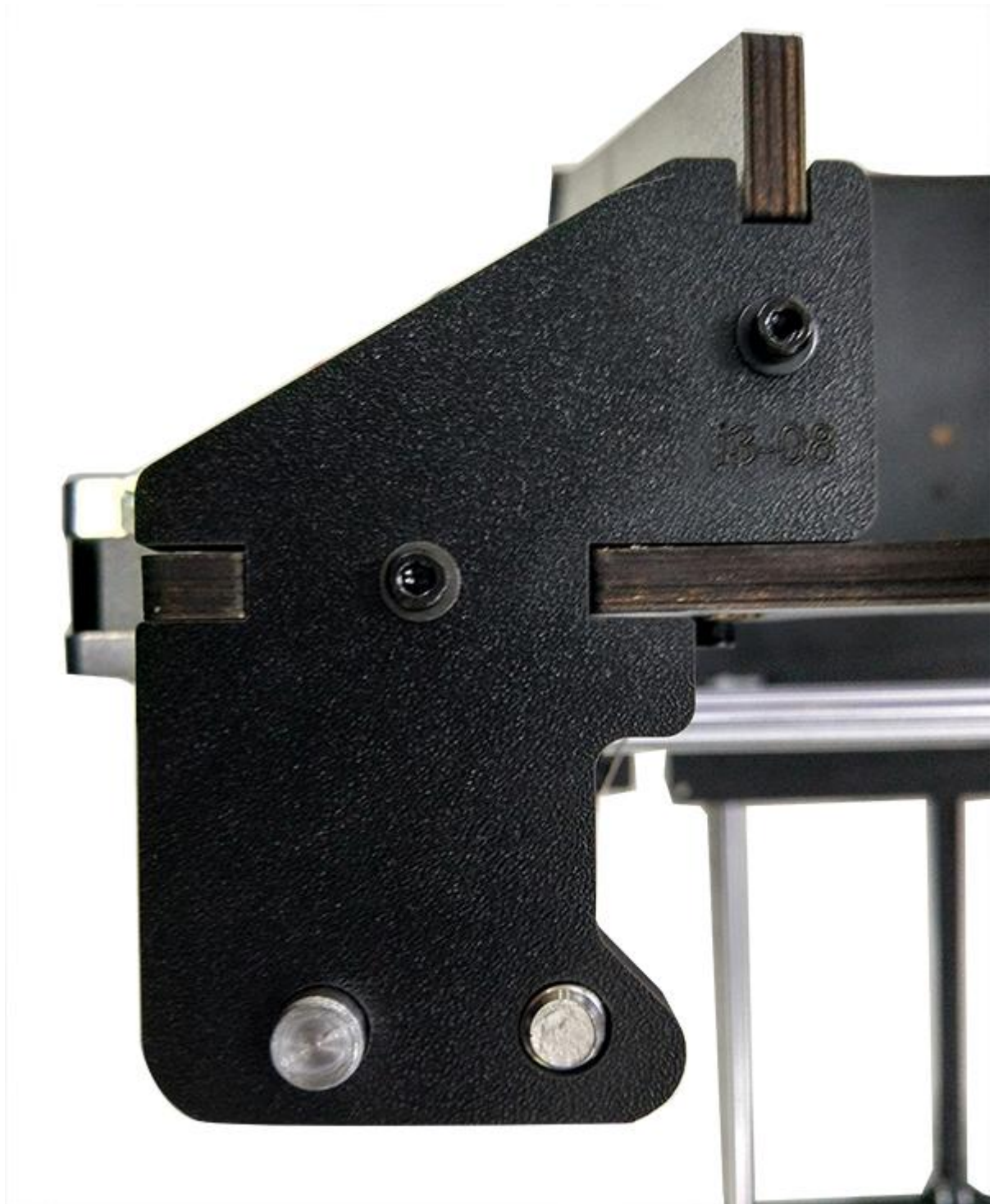

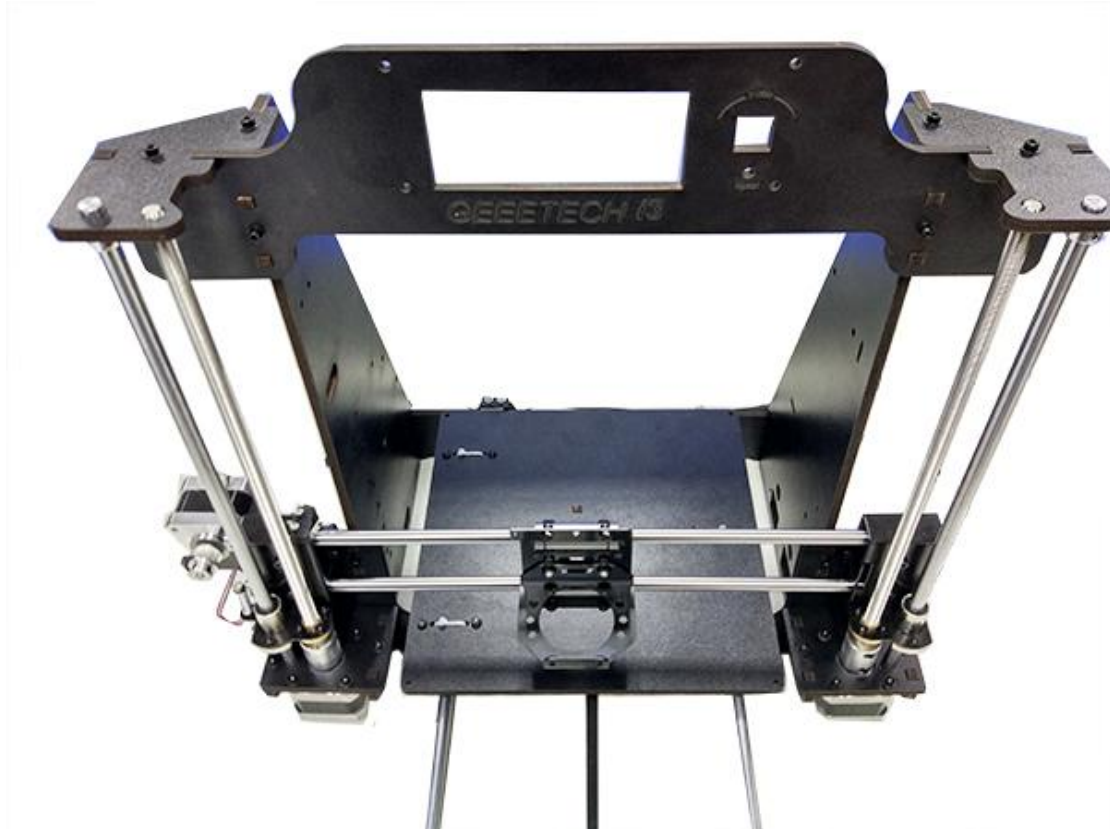

Step 5. After fixing the top mount, the length of X-axis and Z-axis is confirmed. Next is to screw up the both end of X-axis with the locking ring.

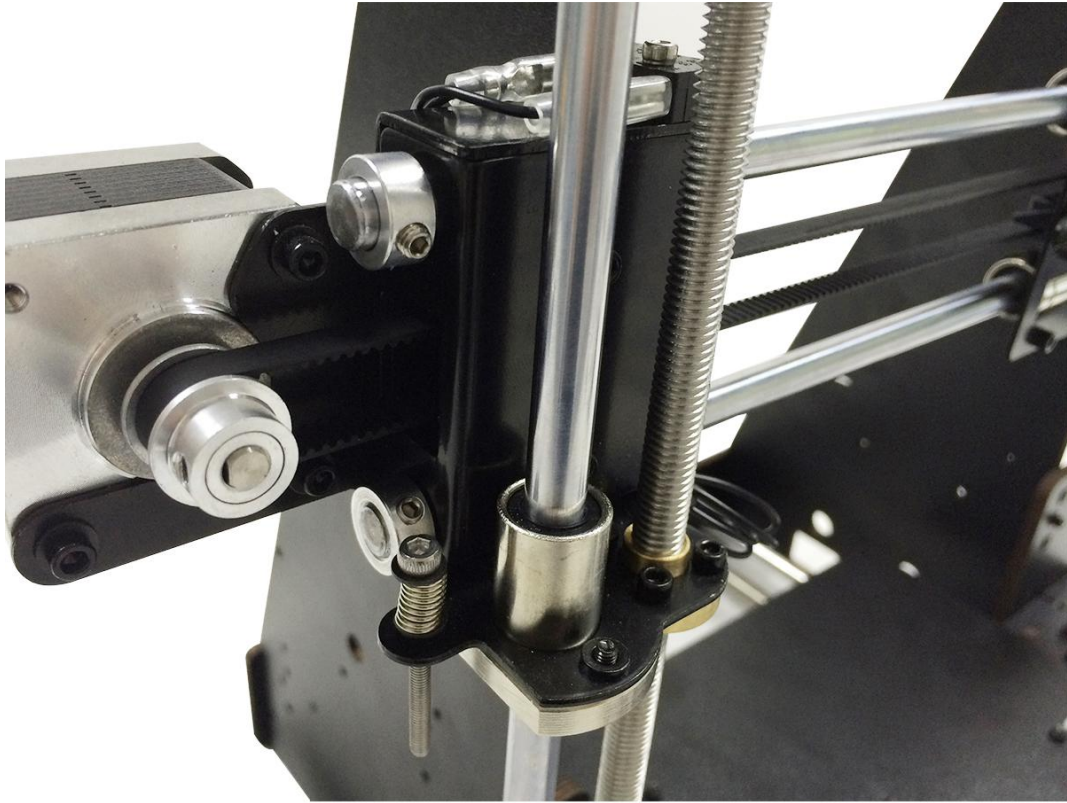





Note: It is very important to make sure the verticality of the smooth rod and the threaded rod of Z axis, the horizontality of X axis, otherwise it will impede the movement of Z axis.

21 Mount the extruder

Required parts	Required Number	Part ID	Picture
----------------	-----------------	---------	---------



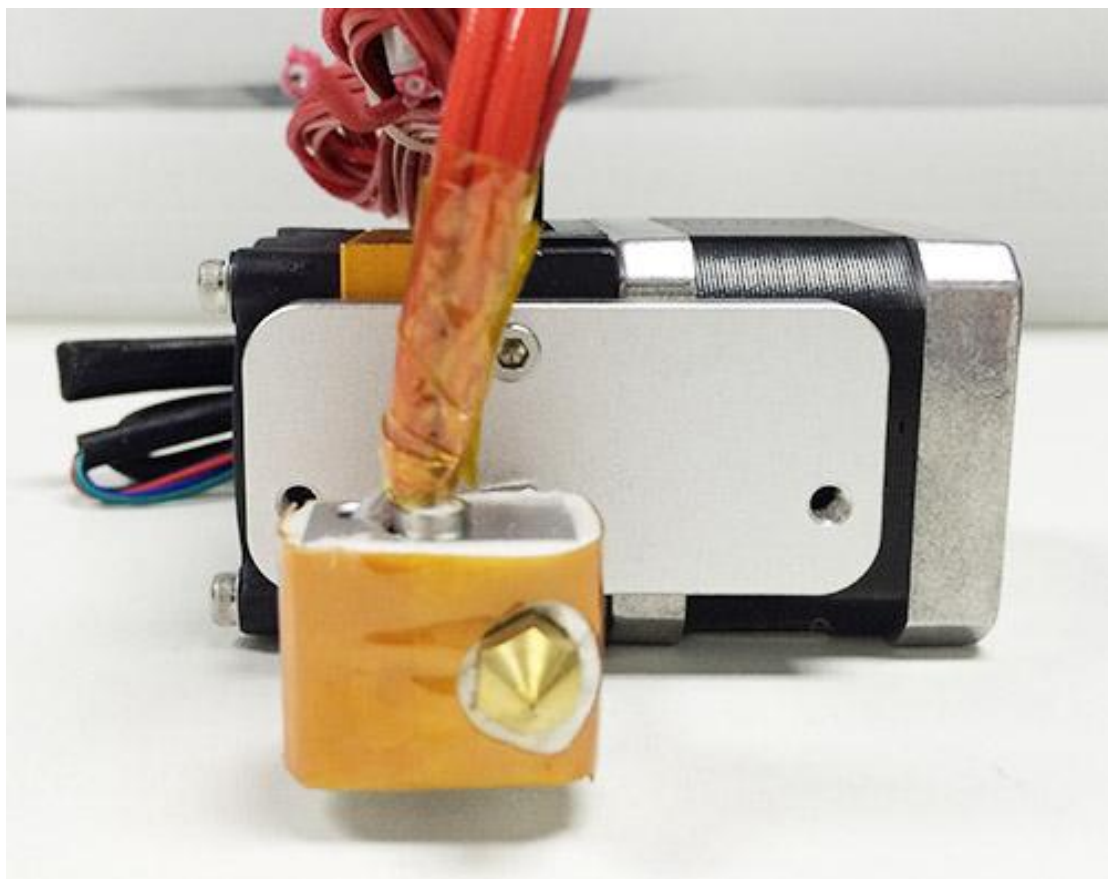

Extruder	1	NO.59	
M4 x 6mm screw	2	NO.28	

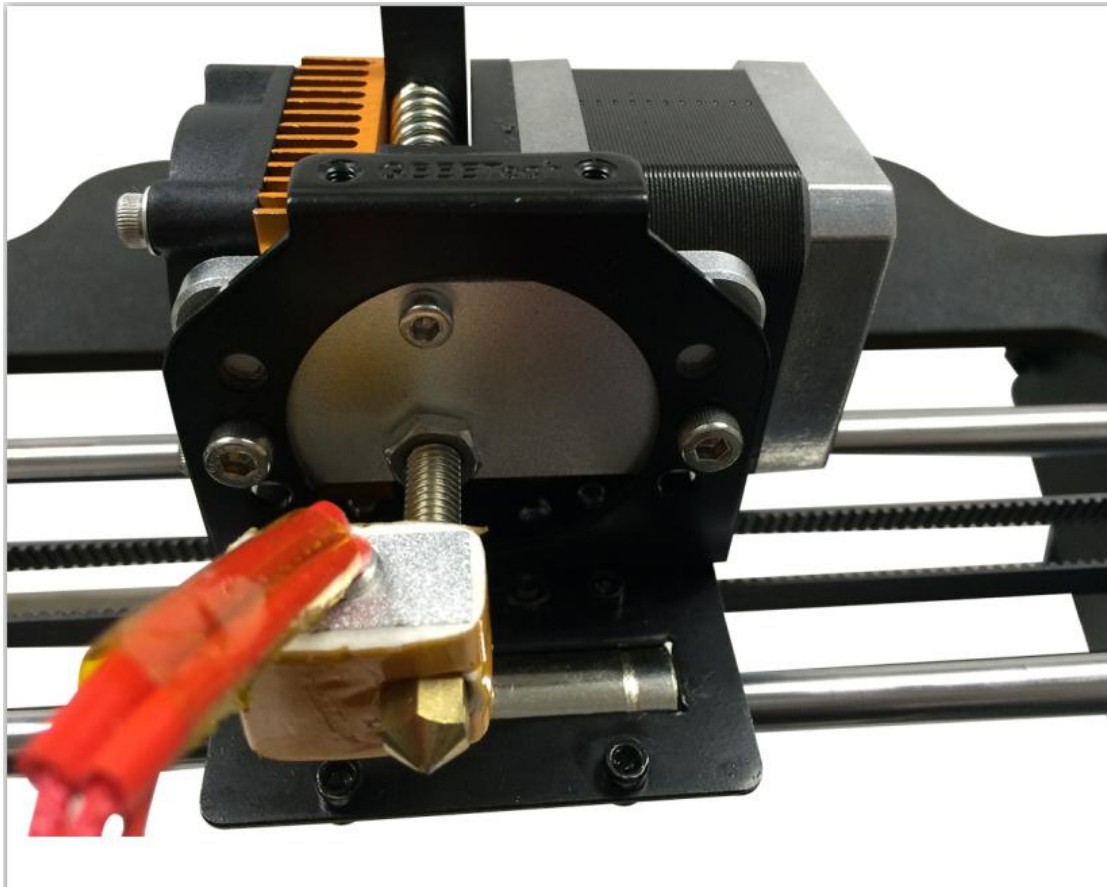

Mount the assembled extruder on the extruder holder and use 2 M4 x 6 mm screws to fix.





22 Assemble X idler

Required parts	Part ID	Required quantity	Picture
Drivenwheel holder	No.37	1	
Driven wheel	No.40	1	
Ball bearing	No.41	2	
M3 x40mm screw	No.27	1	
M4 x 25mm screw	No.29	1	

M4 Lock nut	No.13	1	
Wing nut	No.14	1	

Step1. Thread M3 x 40 screw through the driven wheel holder .



Step2. Insert the driver wheel with the ball bearing into the middle of the driving wheel holder. Put the M4 x25 screw through the driving wheel. Lock the other end with a M4 lock nut. You may need a pair of pliers to tighten locking nut.





*Do not screw it too tight, you should leave enough room for the wheel to turn freely.

23 Add the X axis belt

Required part	Part ID	Required quantity	Picture
Timing belt	No.36	1	

Step1. Insert one end of the belt into the groove. Pay attention to the tooth mesh of the belt and the groove.

Step2. Thread another end of the belt through the X motor end around the pulley.

Step3. Thread the belt through the belt driven wheel and put the M3 x 40 mm screw of the driving wheel into the X idler end, lock it with a wing nut. Not screw too tightly.

Step4. Insert another end of the belt into the groove, pull tightly and cut the spare part.

Confirm the length of the belt. Then insert the belt into the groove.

Step5. Taut the belt and tighten the wing nut on the idle end.

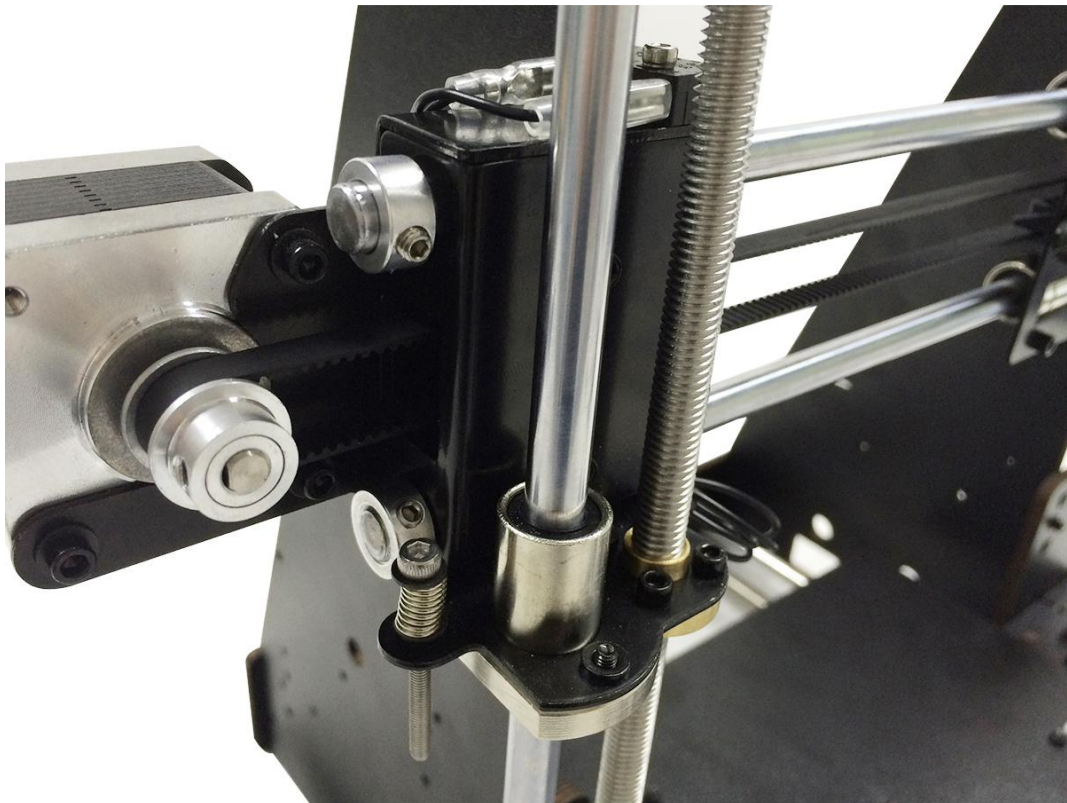
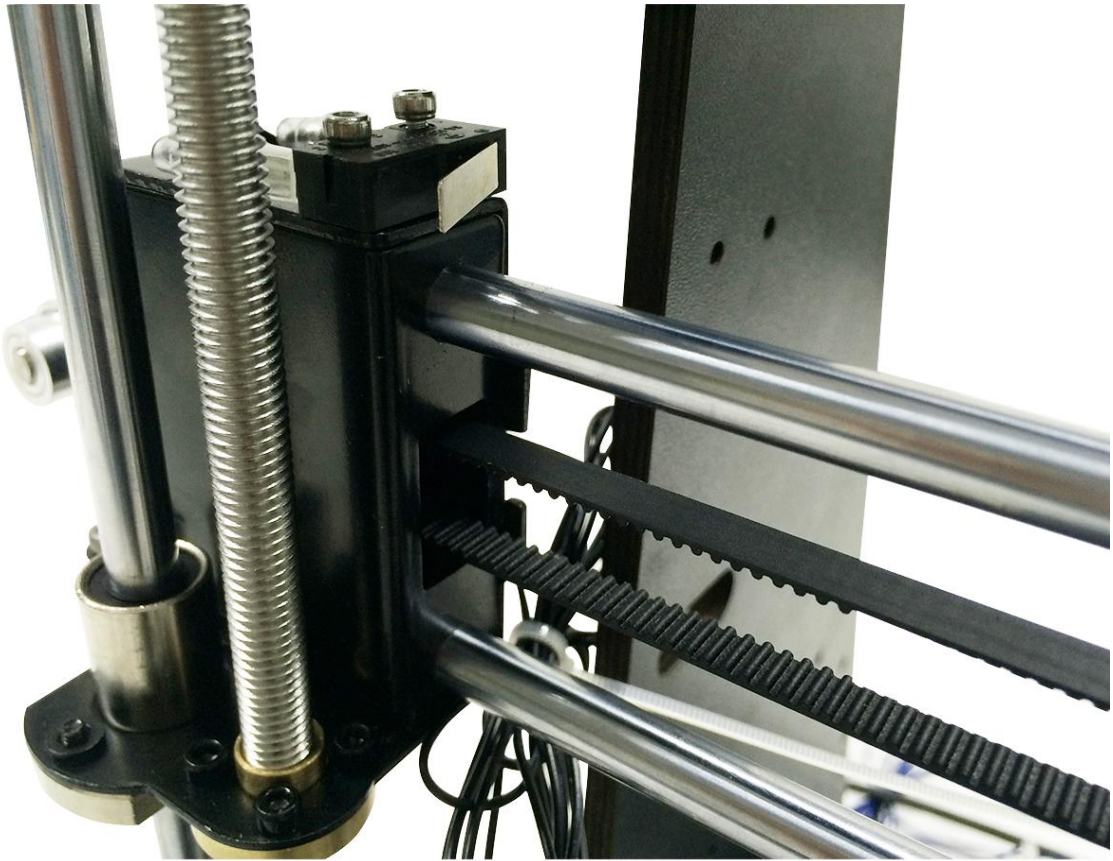

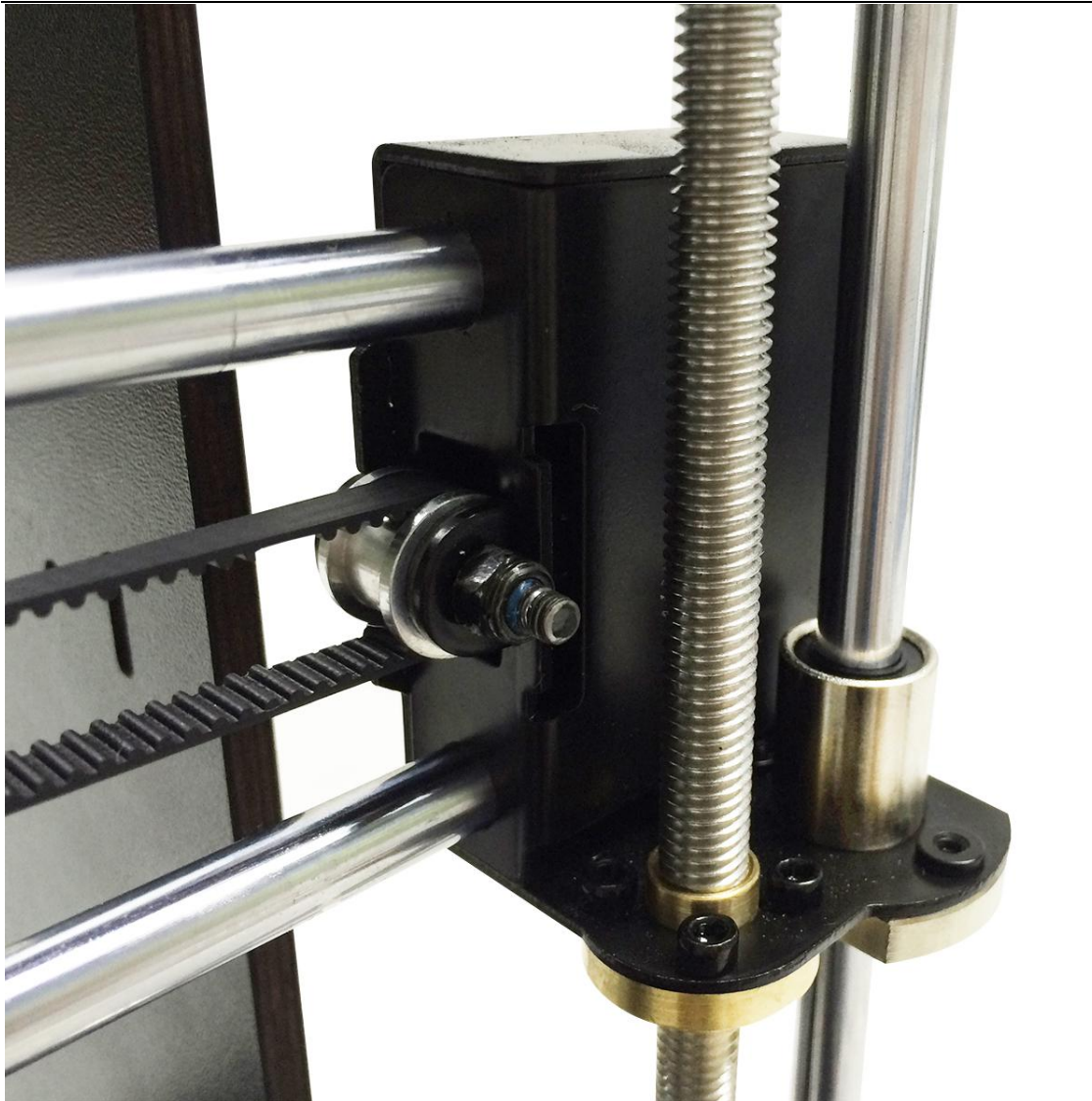





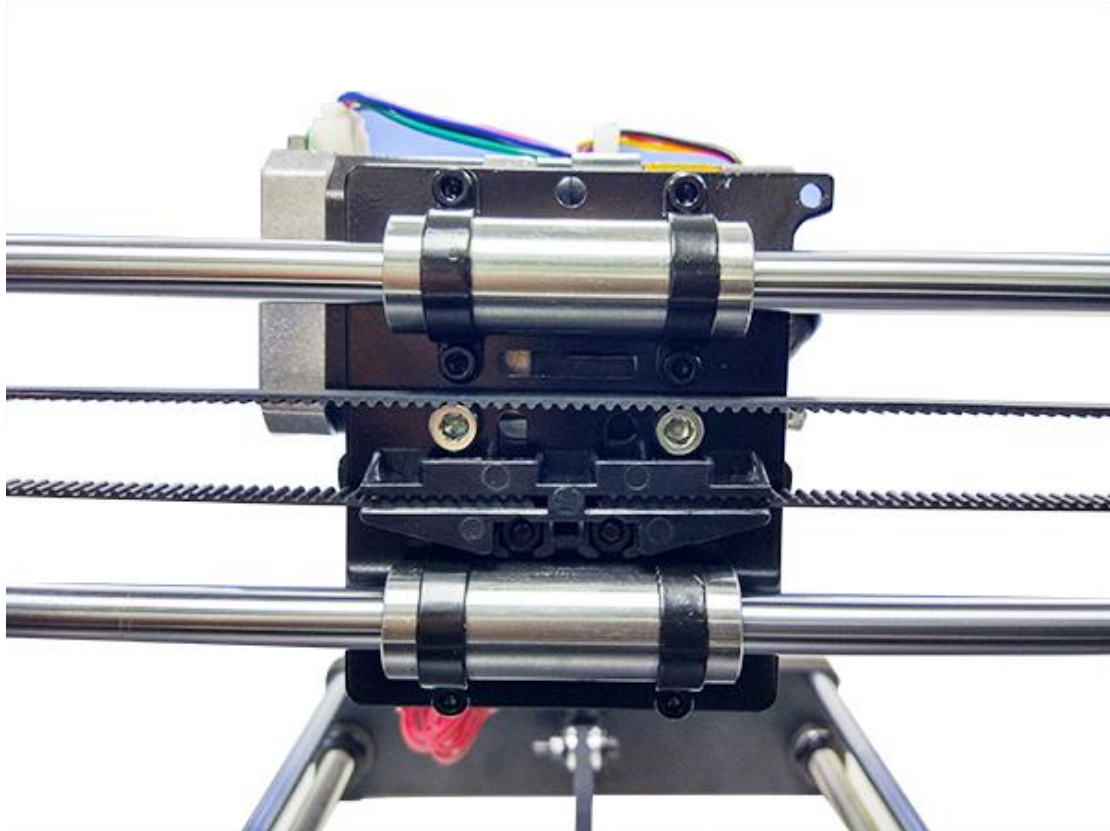

*Note the direction of the driven wheel, the side with lock nut should be outward, or it will scratch the wood plate.





24 Mount the LCD panel



Required parts	Required quantity	Part ID	Picture
LCD 2004	1	NO.61	
Spacer	4	NO.43	
M3 x 16mm screw	4	NO.24	
M3 nut	4	NO.10	

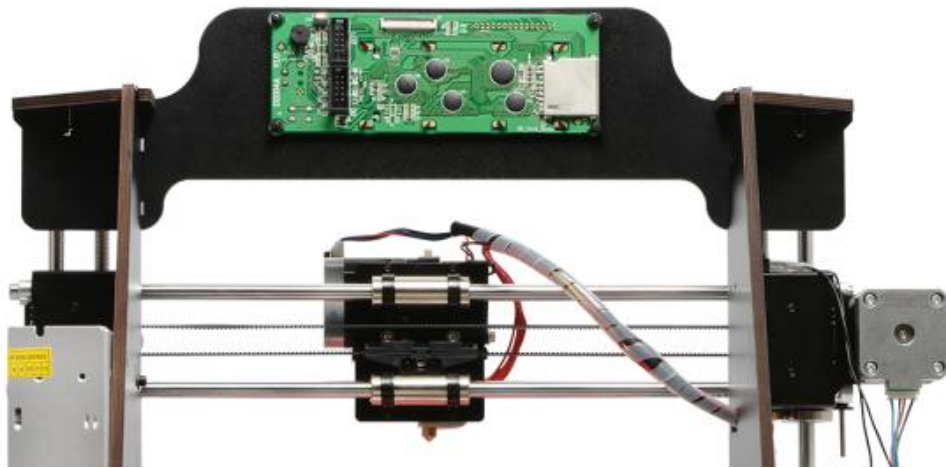

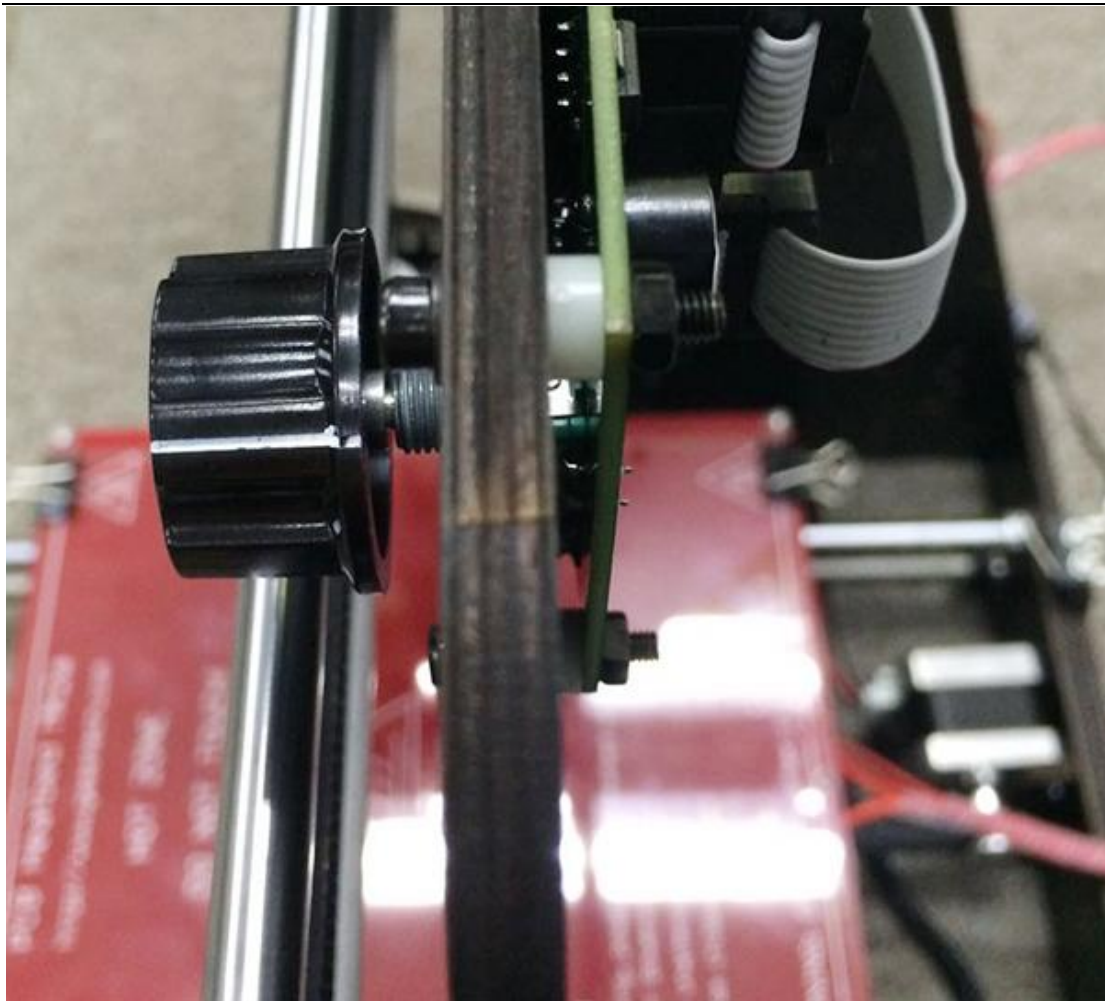

Konb	1	NO.48	
M3 washer	6	No. 7	





25 Attach the heated bed

Required parts	Required quantity	Part ID	Picture
Heat bed set	1	NO.55	
M3 x35mm screw	4	NO.26	
M3 washer	12	NO.7	

Spring	4	NO.31	
Dovetail clamp	4	NO.44	
Wing nut	4	NO.14	
Borosilicate glass	1	NO.56	

Mount the heat bed on the platform with 4 M3 x35 screws, M3 washers and wing nuts.

Clamp the heat bed and the glass sheet.





***The soldered side is better to be attached downwards.**



The order should be:

M3 x35mm screw—washer—Heat bed—Spring—washer—Wood support plate—
washer—Wing nut



26 Mount the PSU

Required parts	Required quantity	Part ID	Picture
Power supply unit	1	NO.57	
M3 x 10 mm screw	3	NO.22	
M3x16mm Countersunk head screw	2	NO.30	
M3 nut	2	NO.10	

M3 washer	5	No. 7	
Power input cable	1	NO.53	
Power output cable	1	NO.54	

Step1. Take off the wires connected to the socket; before you do, please take a photo of the wire connection, in case you connect them wrongly later.

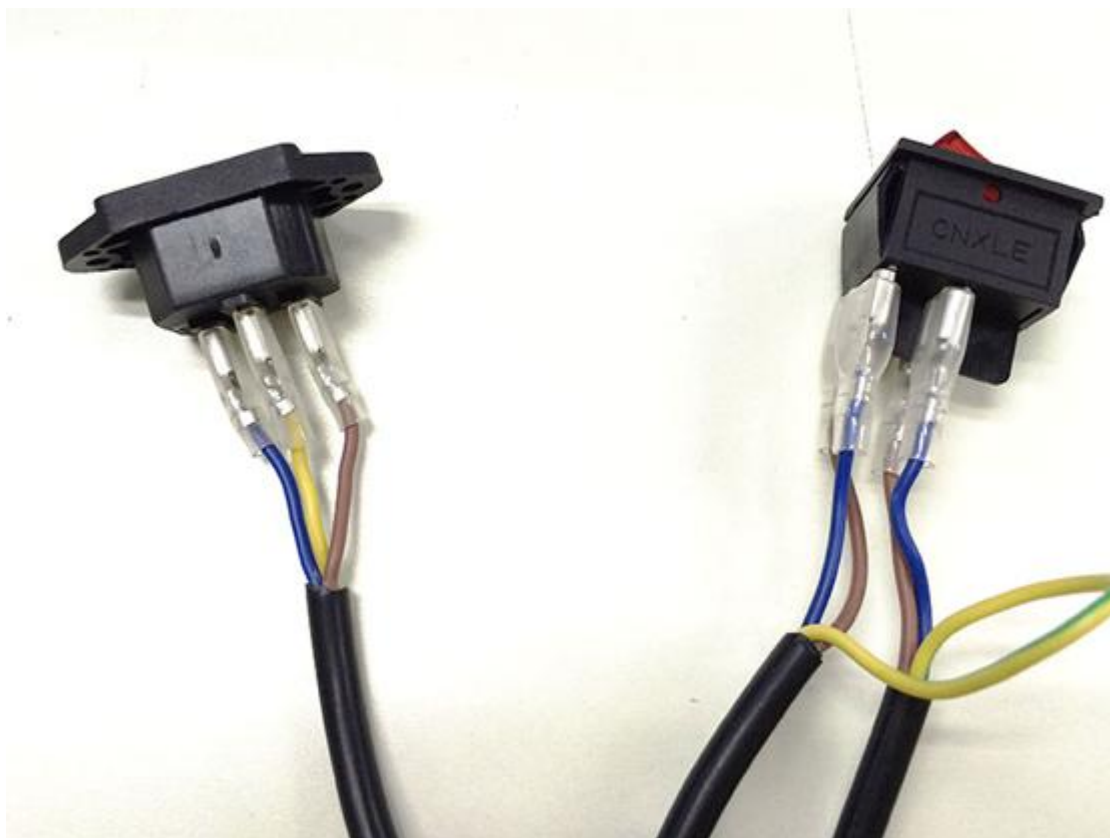

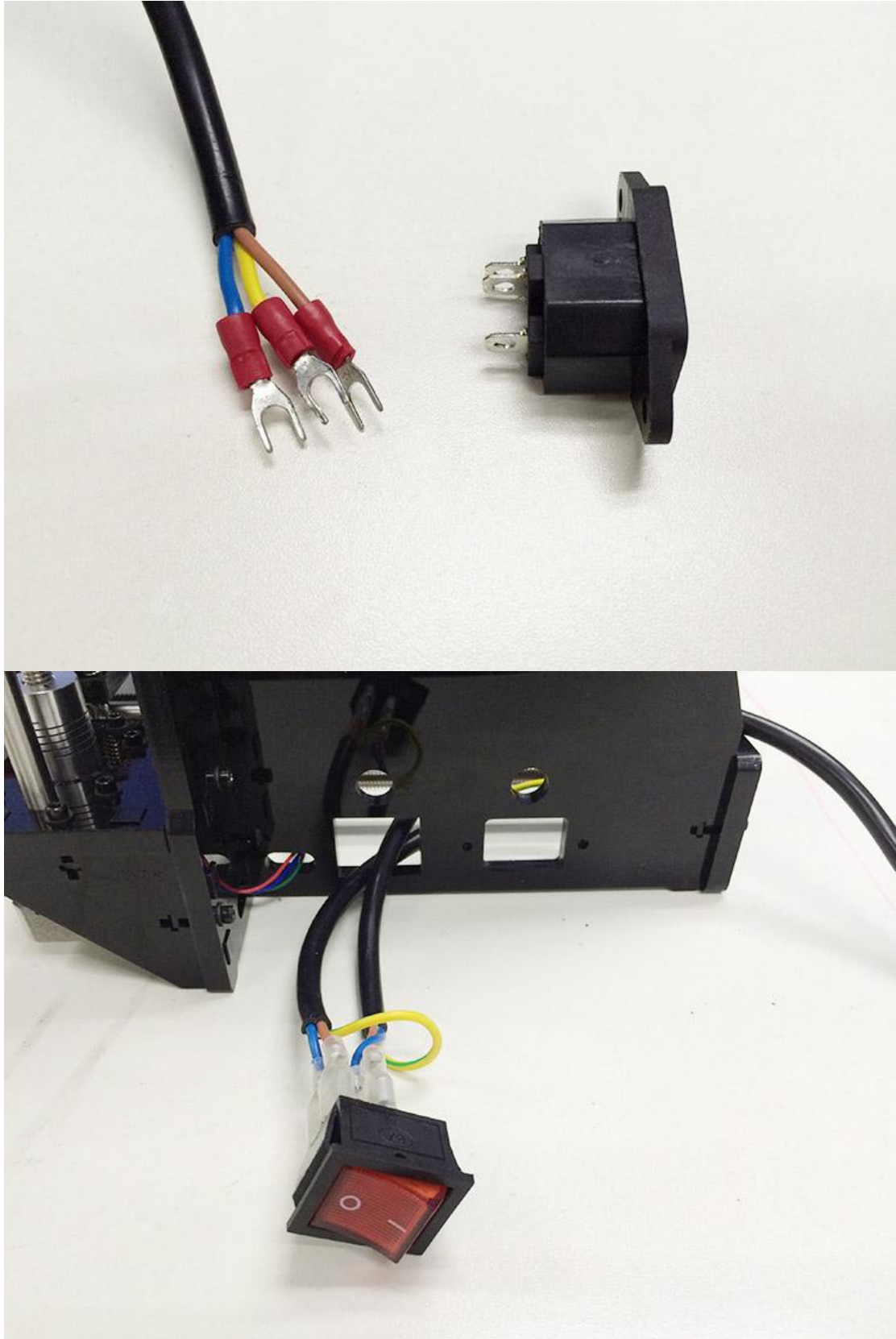



Step2. Mount the socket on the bottom of the right side panel with 2 M3 x 16 Hex Counter- sunk-head screws ,M3 washer and M3 hex nut.



Step3. Put the power outout cable in the bottom of the printer, then thread it out from the hole on the right side panel.

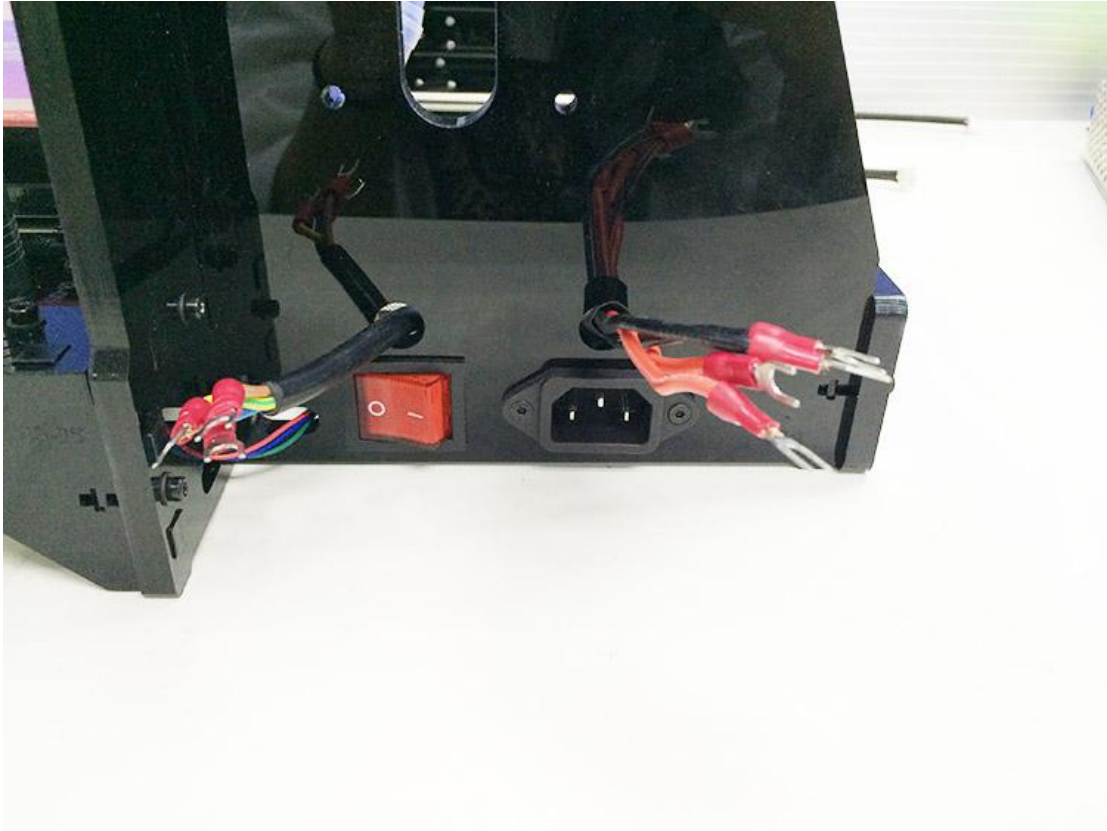

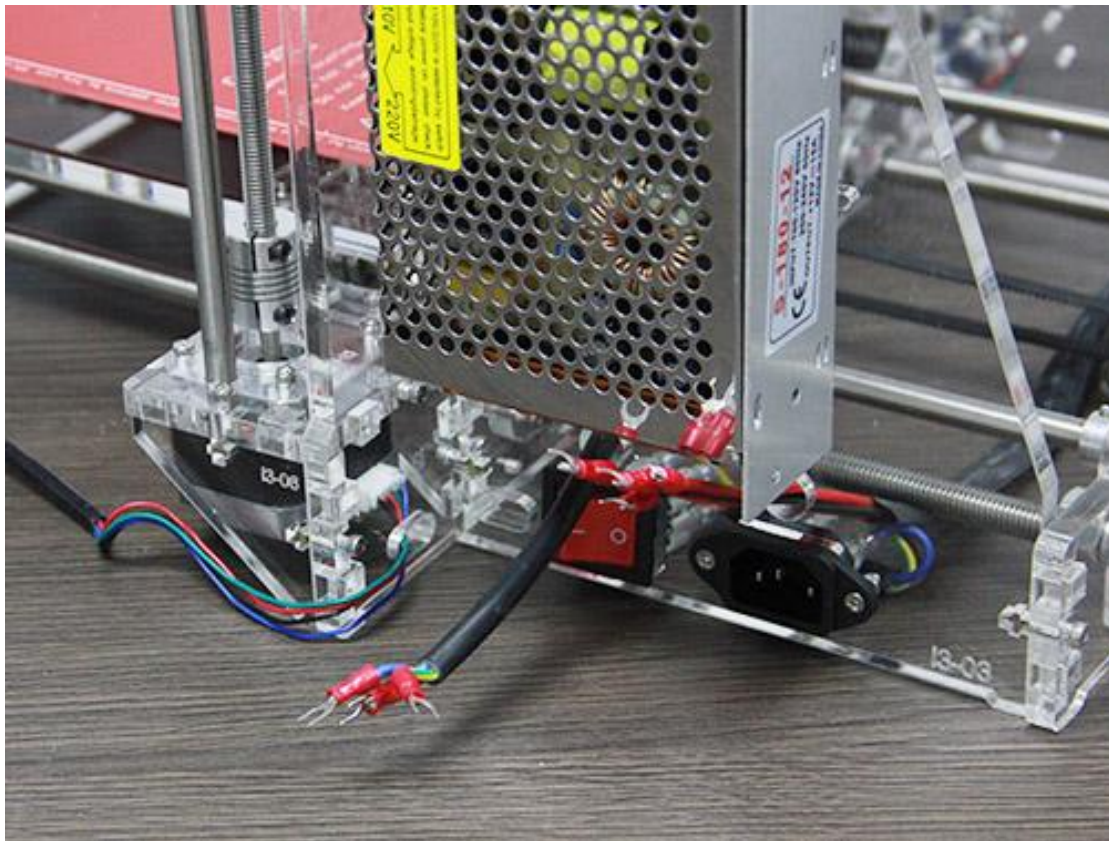

(Use the transparent pictures of Pro W to conveniently display the inner part to the user.)

Step4. Mount the PSU (Power supply unit) on the right side panel with 2 M3 x 10mm screws,M3 washers.

Pay attention to the switch on the right side of the PSU, there are two options of voltage: 110 V and 220V, choose according the standard in your country. As shown in the following picture. Remove the yellow paper; you can use some hard sticks to reach the switch.

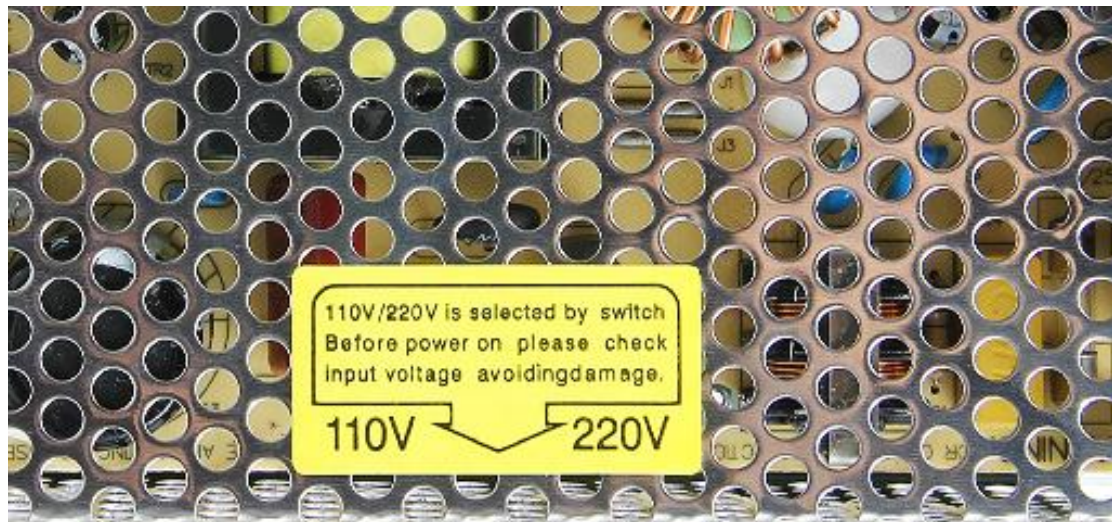





Step5. Now we can connect the wires to the PSU.

Mind the color of the wires. The wrong connection of the wire will cause serious damage to the PSU and even to the control board of the printer.

As you can see, there are 7 wires terminals in total.

Note the correspondence between the color of wires and the connector.

After finish the connecting, close the cover of the connector in case any electric shock.

Brown-----L

Blue -----N



Yellow----- GND

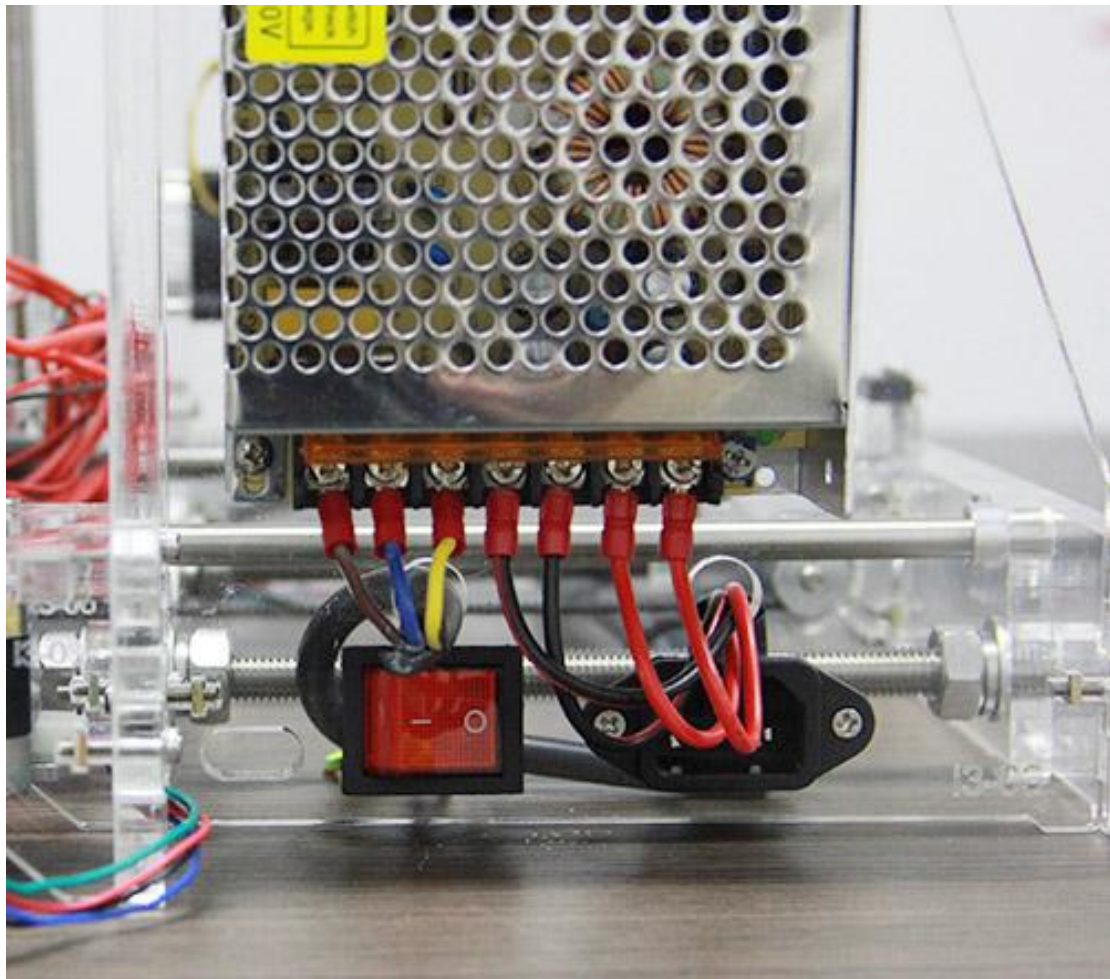

Red ----- ++ V

Black-----COM



27 Mount the control board

Required parts	Part ID	Required quantity	Picture
Control board	No.60	1	
Sticker	No.46	1	
Heat sink	No.45	1	

Spacer	No.42	4	
M3 x 10 mm screw	No.22	4	
M3washer	No. 7	5	

1. You can also mount the board after you finish the wiring so that you can see the Silk print on the back of the board
2. Some connectors on the board may vary in different batches, but the layout of the board are the same, it will not affect the wiring.

Step1. Cut the sticker into small pieces. Past the heat sink onto the chip of the A4988 drivers (on the main board).

Step2. Insert the spacer into the holes of the board from back to front, Mount the board kit on the left side panel with 4 M3 x 10mm screws and M3 washers on the side panel.

Note the direction of the board; the section insered A988 is are upwards.

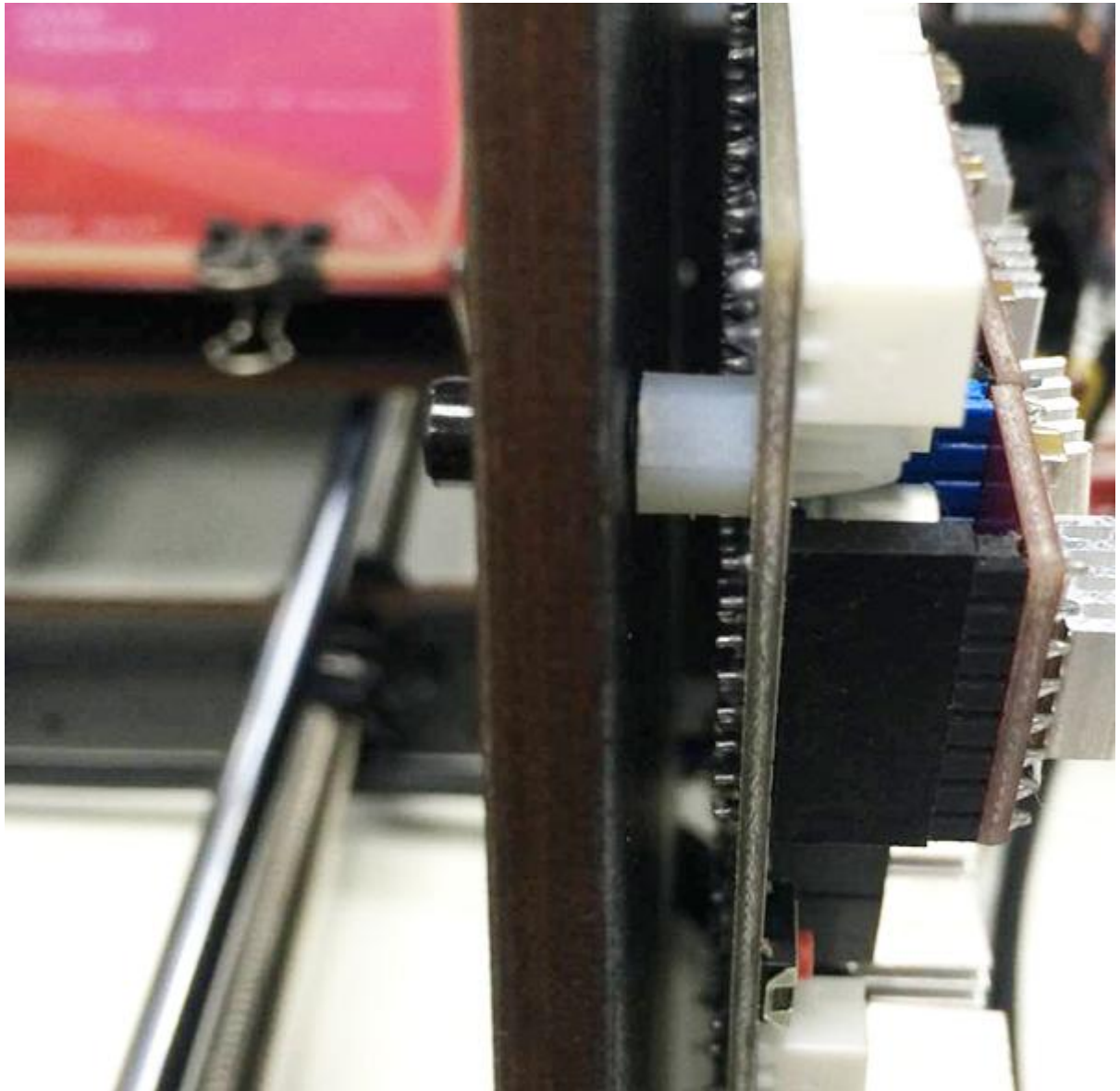

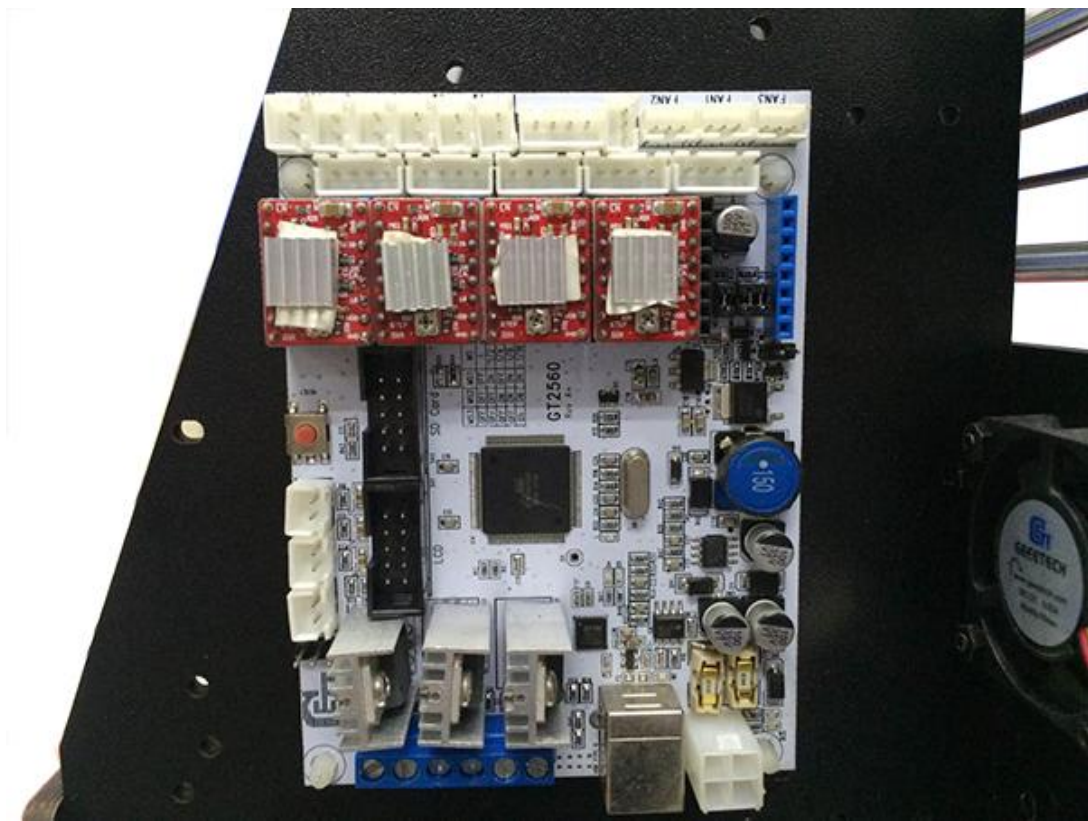

28 Wiring

Mainboard: GT2560

Before you start wiring; please take a look at the wiring schematics.

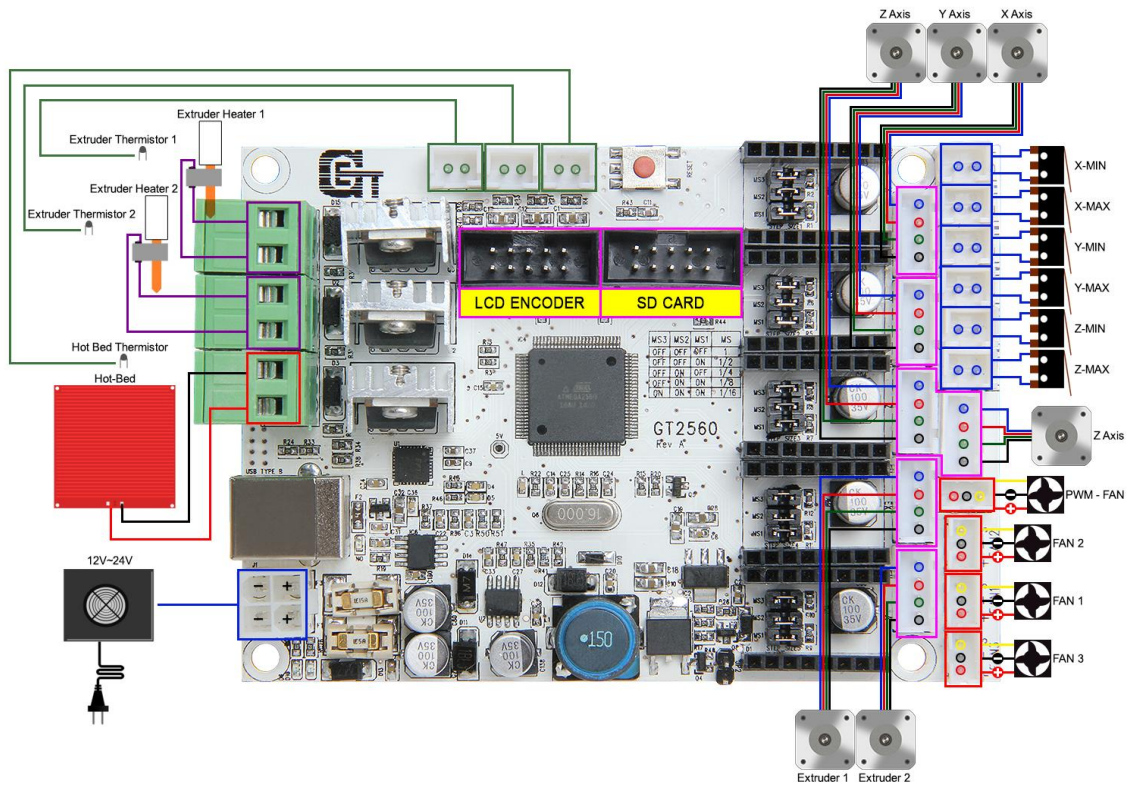

Note: Different batches of main board, the color and the model of the heating terminal may be different, but all layout of interface is same.

You can see original picture [here](#).

For your convenience, the first two steps are finished, you can directly start from step 3.

Step1. The subdivision of stepper motor can be setup by jumper cap, plug all the jumper caps.

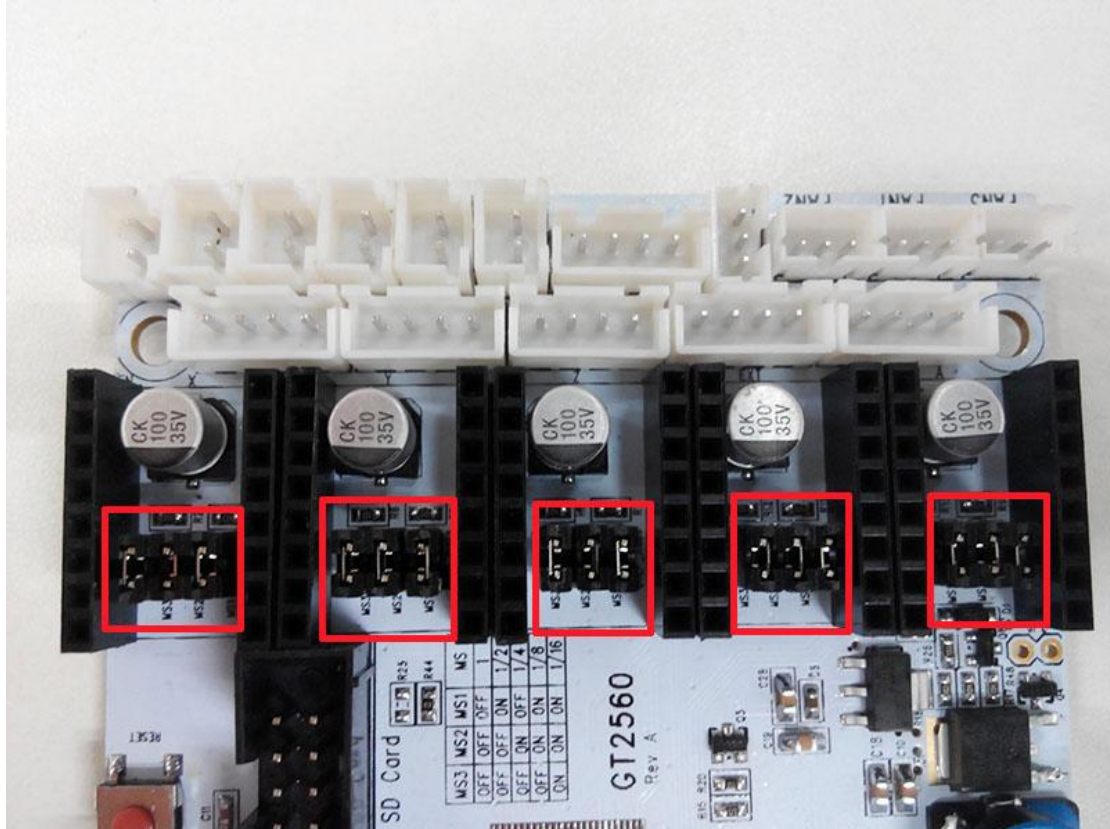

Step2. Plug the 4 A4988 into the stepper motor driver slot. Mind the directions of A4988.

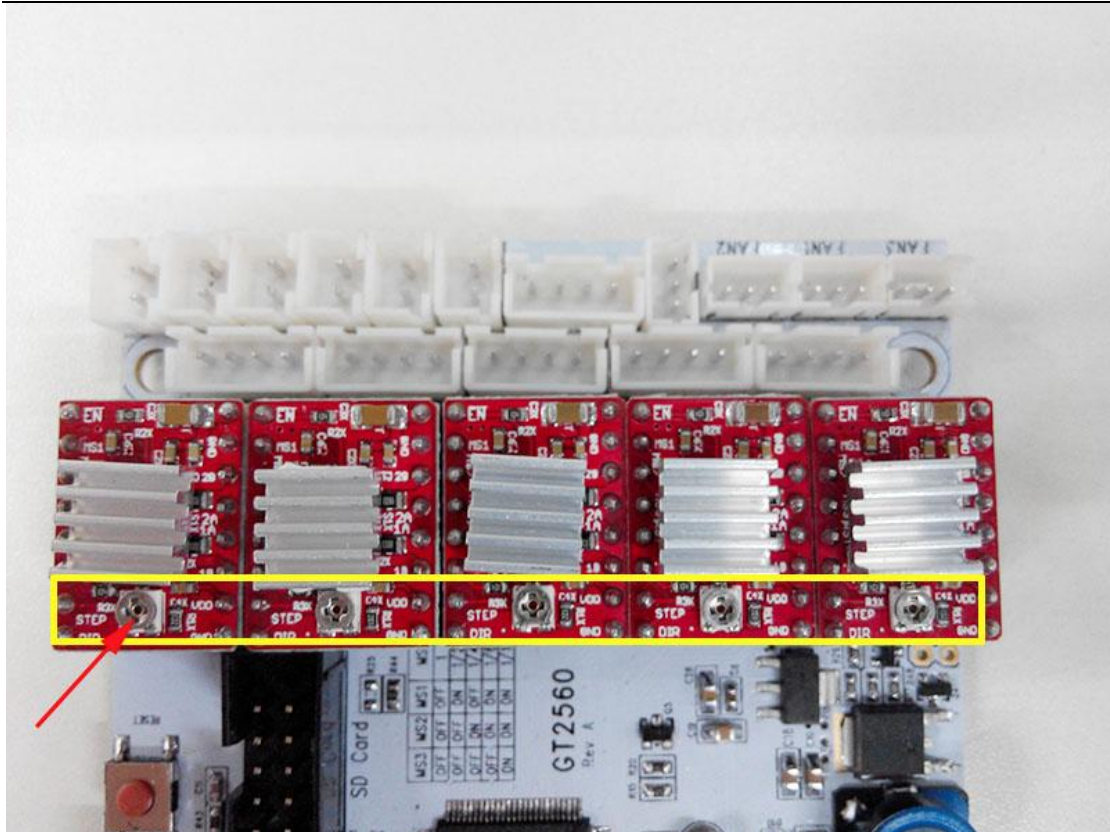

Step3. Connect wires for motors.

1) Connect wires for X-axis motor.

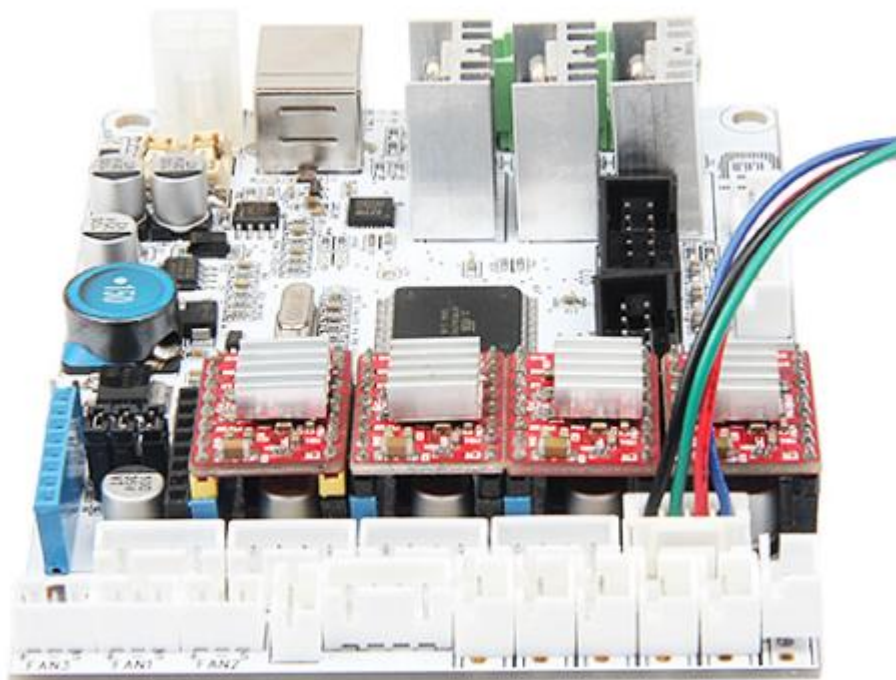

2) Connect wires for Y-axis motor.

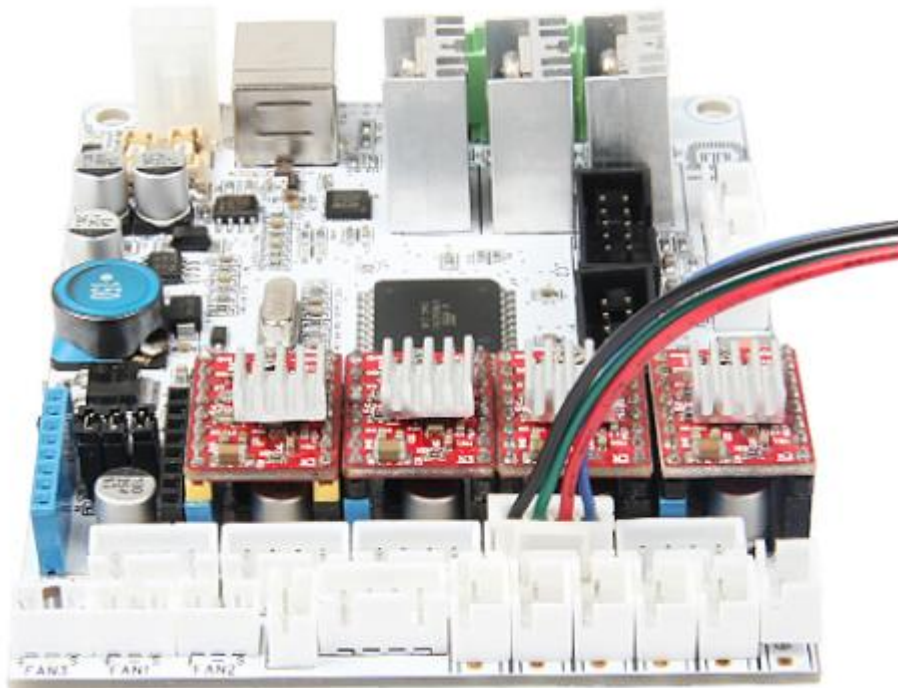

3) Connect wires for 2 Z-axis motors.

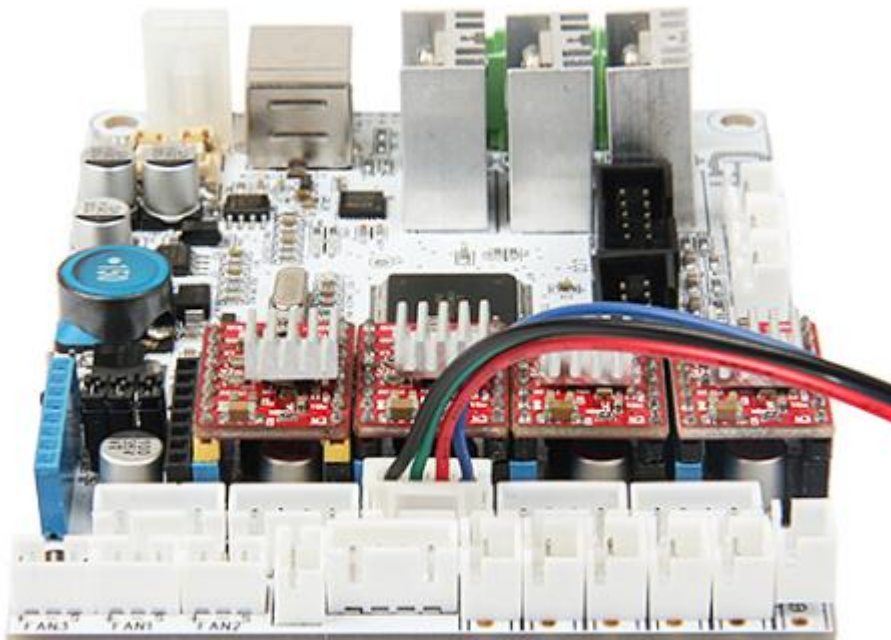

(Z-axis motors-left)

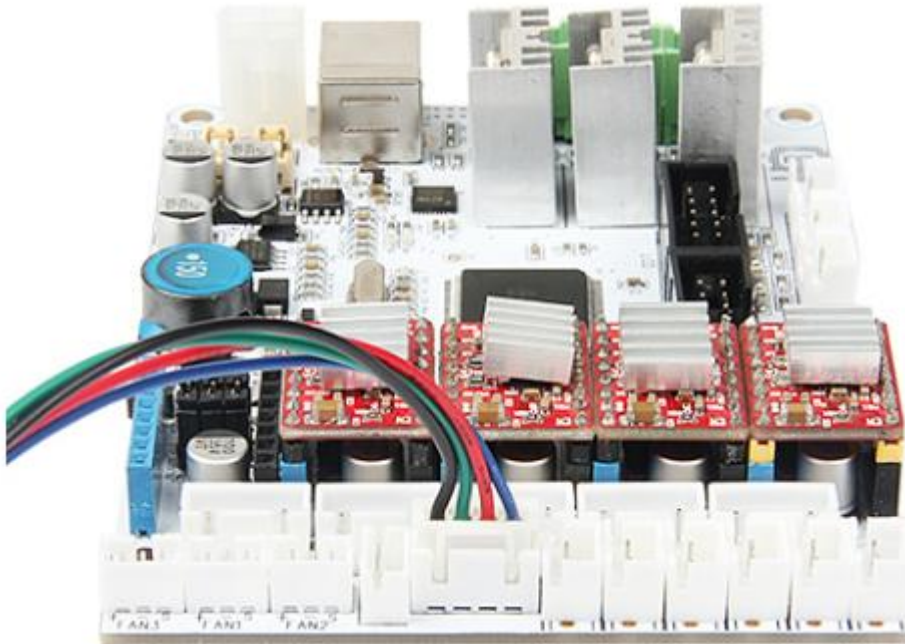

(Z-axis motors-right)

4) Connect the cables of Extruder motors.

There are two interfaces of the extruder motors,here is coonecting with the extruder 1.

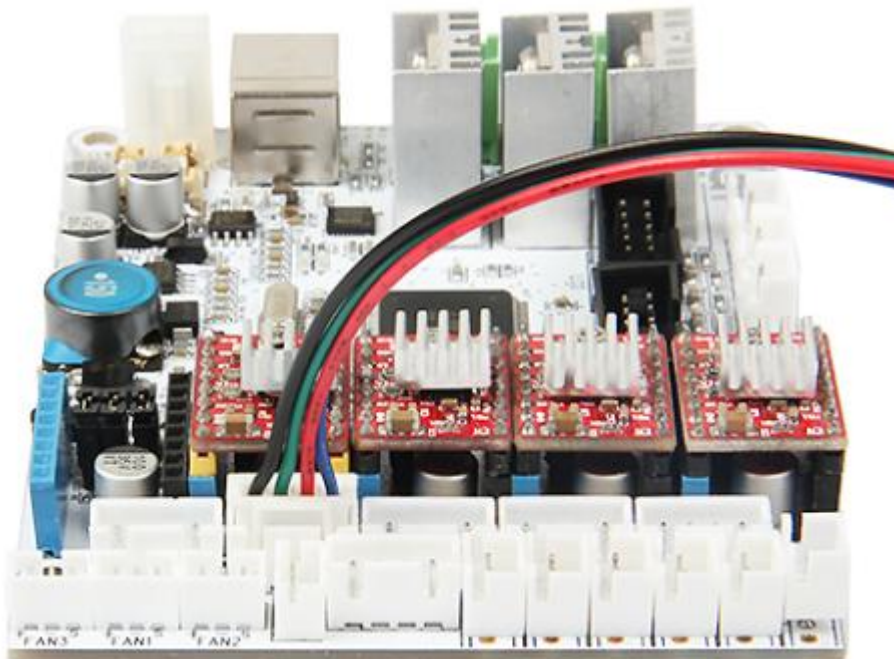

Step4. Connect heating wires.

Loosed the screws in the green terminal and put the red wires into the slot and screw it up. * There is no “+” and “-“for heating wires

- 1) Connect heating wires for heatbed.

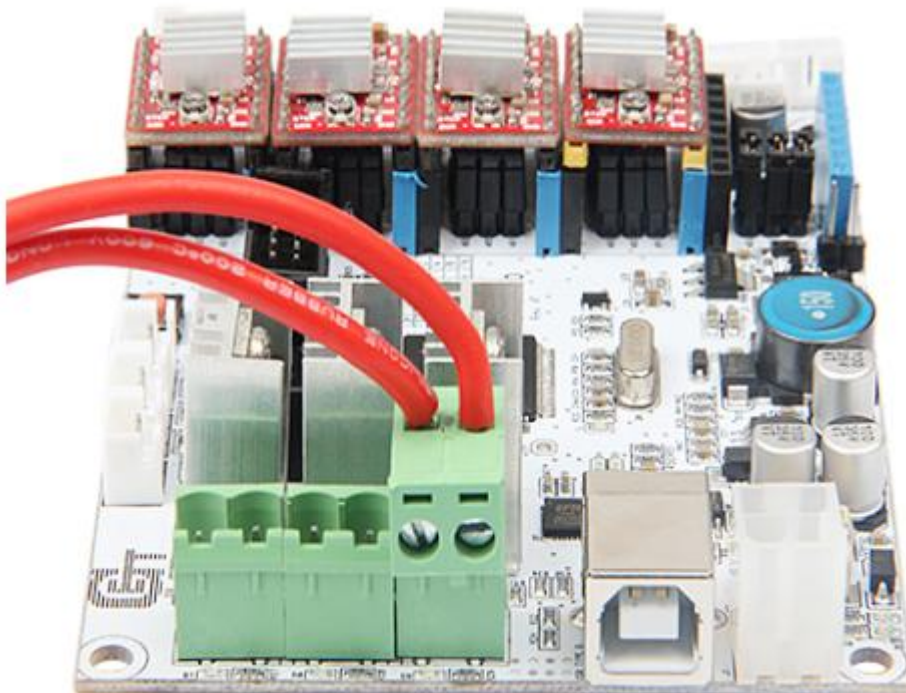

- 2) Connect heating wires for extruder 1.

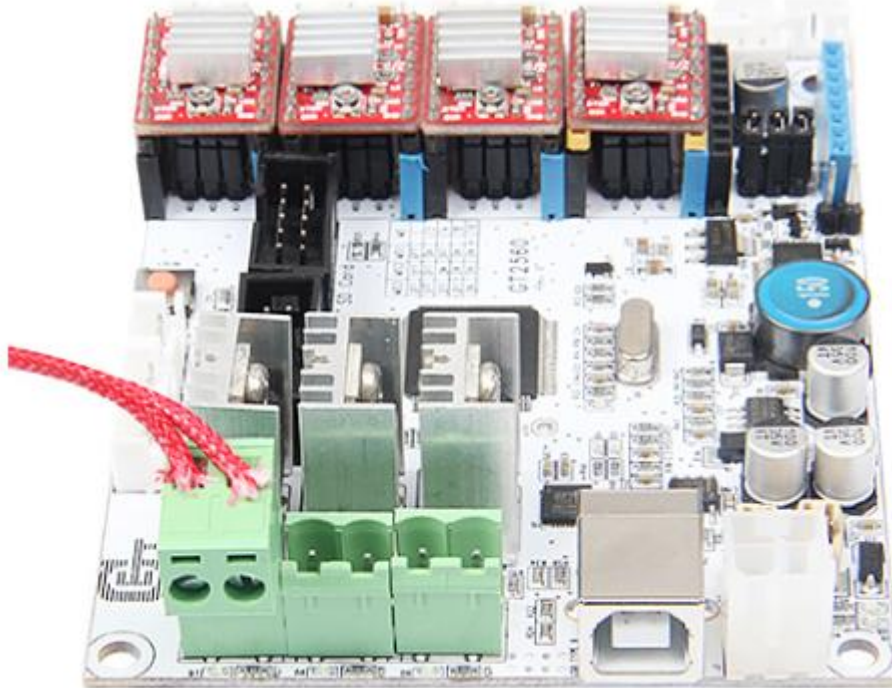

Step5. Connect wires for thermistor.

- 1) Connect wires for thermistor of heatbed.

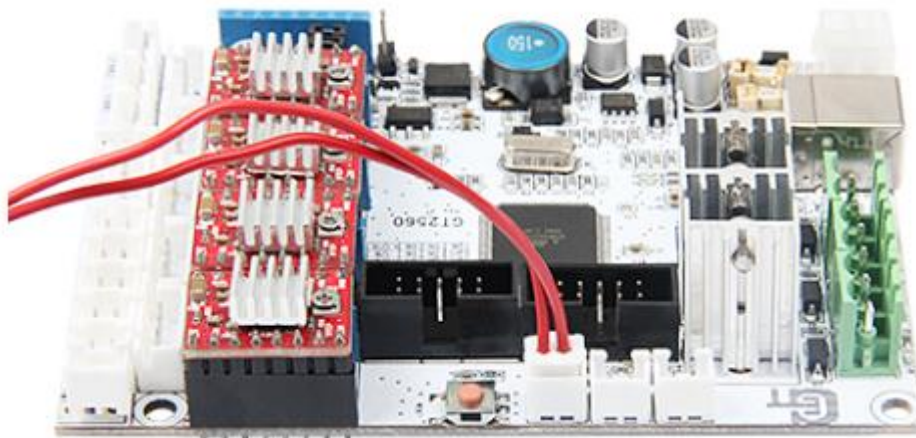

- 2) Connect wires for thermistor of extruder 1.

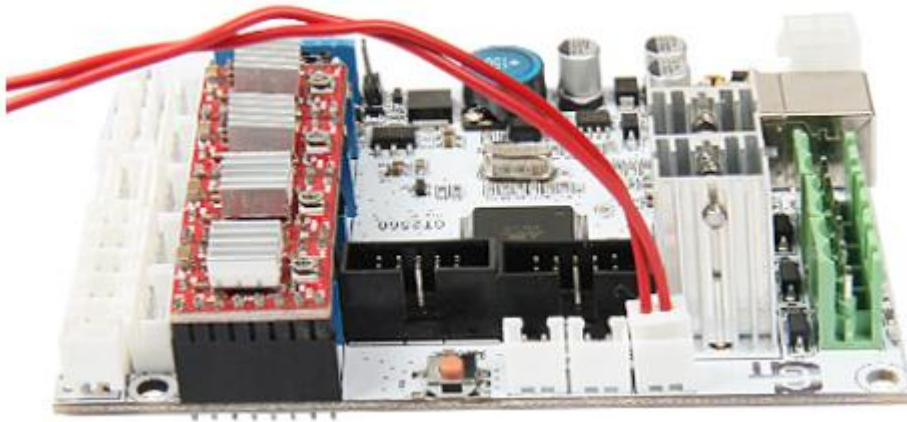

Step6. Connect wires for endstop.

Connect wires for endstop of X-axis at X-Min.

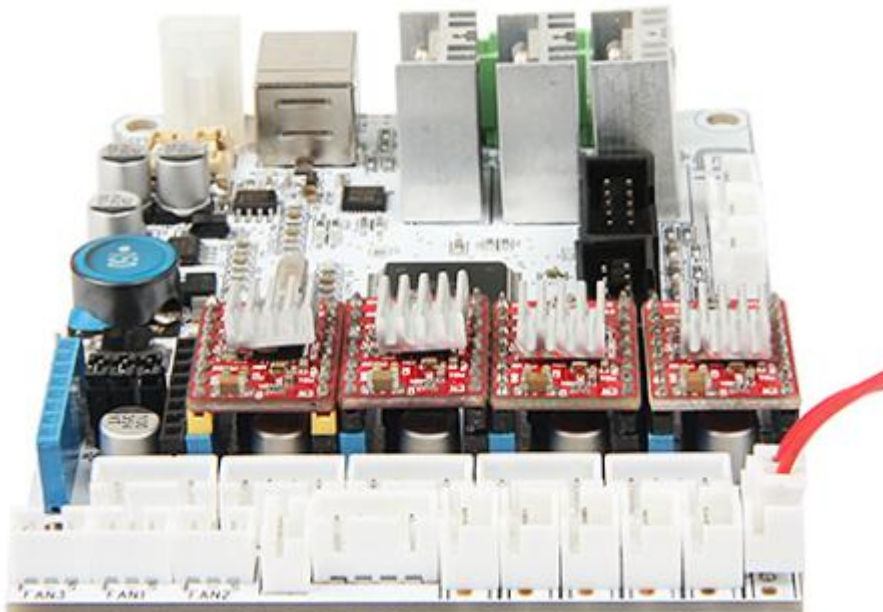

2) Connect wires for endstop of Y-axis at Y-Min.

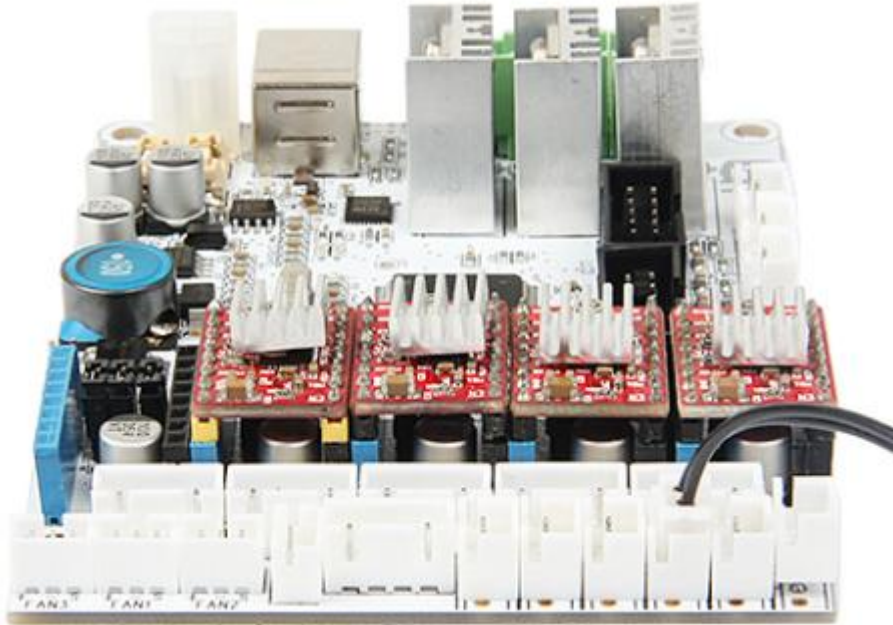

3) Z-Min Connect wires for endstop of Z-axis at Z-Min.

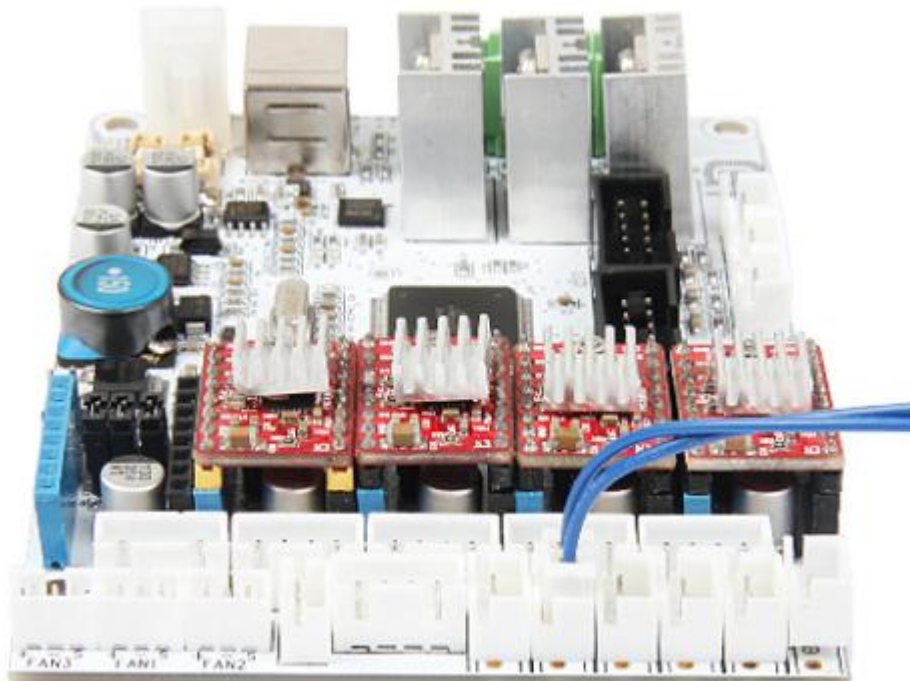

Step7. Connect wires for Fan.

1) Connect fan for control board at FAN3.

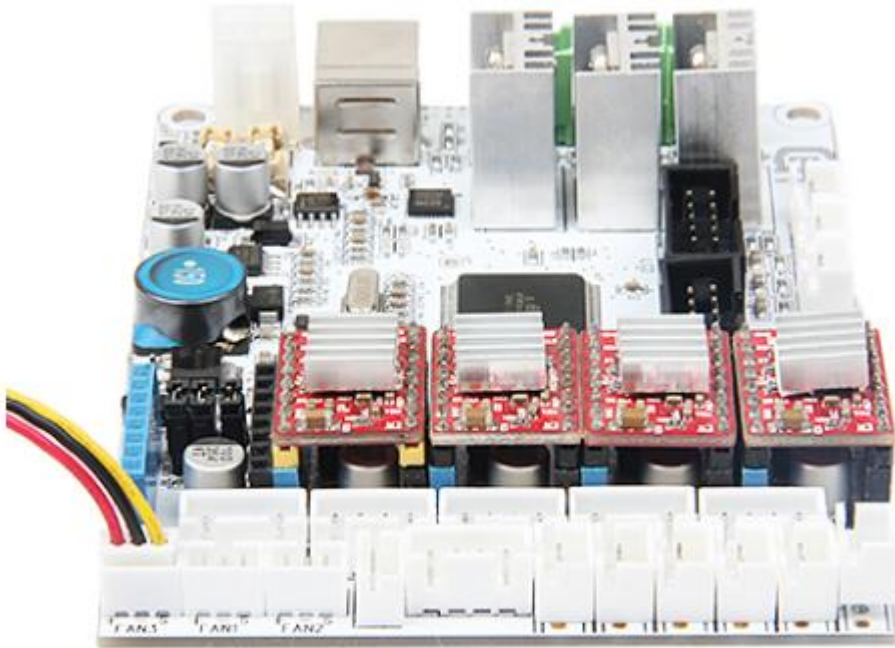

2) Connect fan for extruder at FAN1.

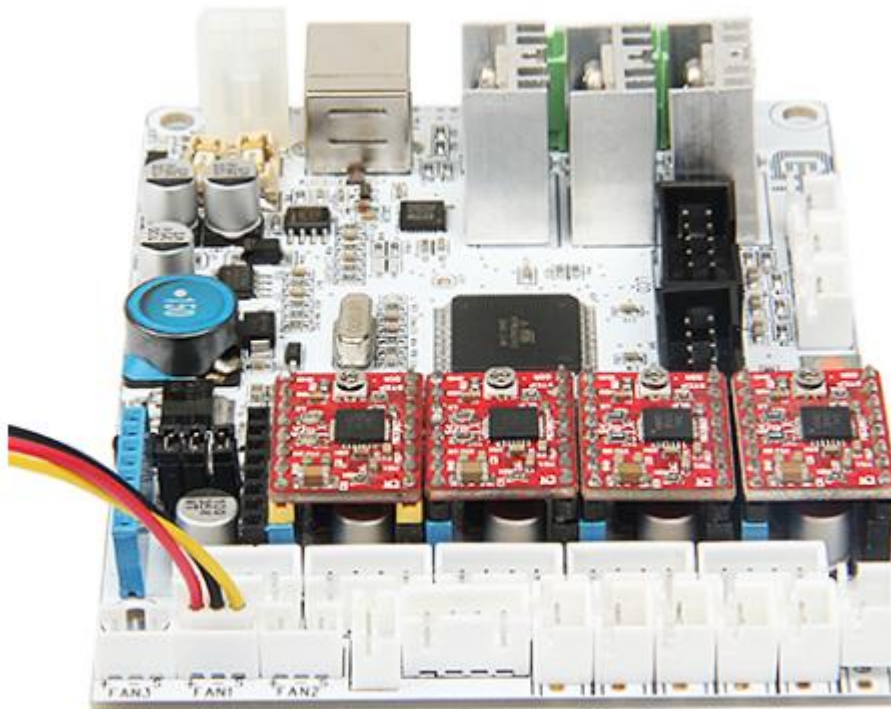

Step8. Connect wires for LCD panel.

There are two cables, one is for LCD encoder, the other is for SD card, do not connect them reversed.

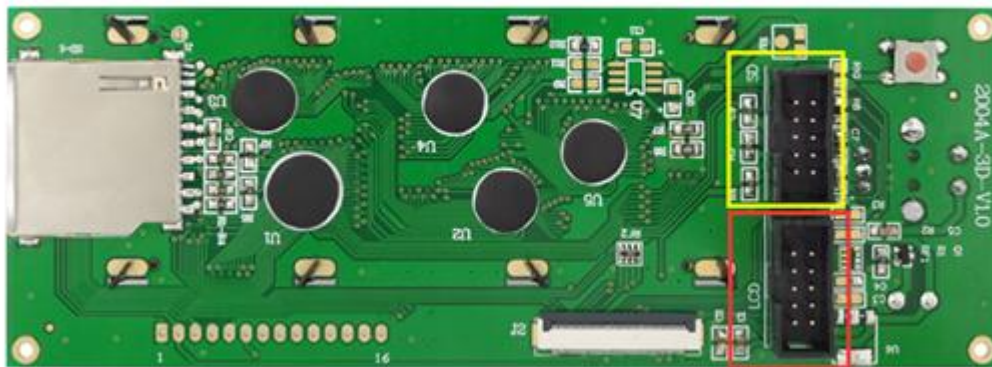

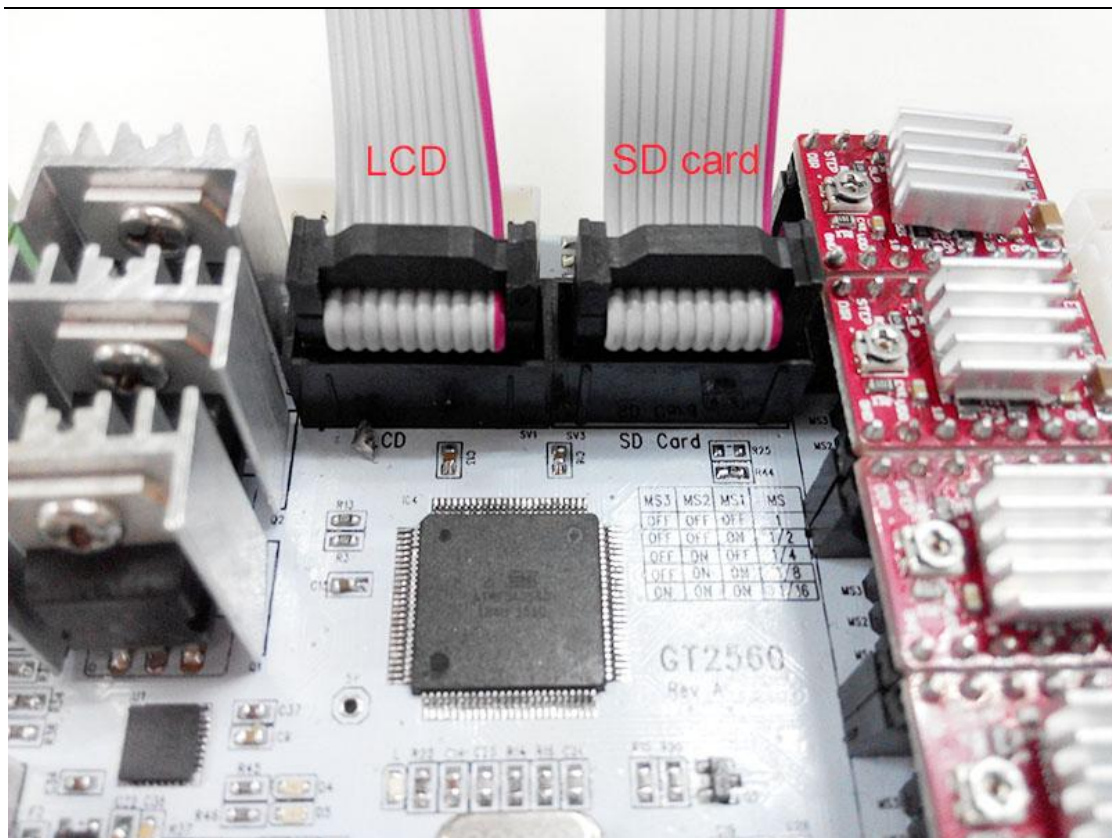

Step9. Connect wires for power input.

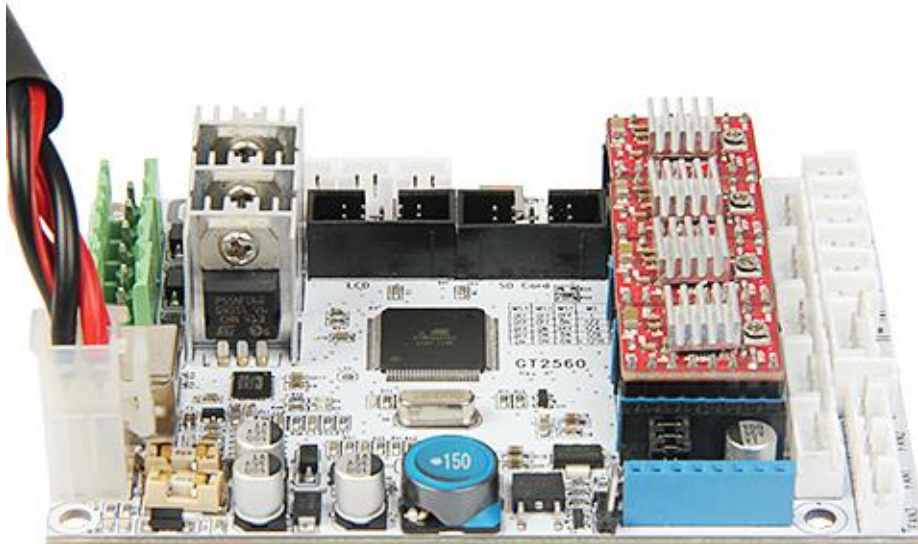





That is all for the wiring of GT2560.If any questions, please contact with us in any time.

29 Tidy out the wires

Use the wire coil to tie put those wires together. There are holes on the wood plates for the wires, you can arrange them as you like.

30 Mount the filament spool.

Required parts	Required quantity	Part ID	Picture
Filament side panel			
M3 x 16 mm scew	4	NO.24	
M3 square nut	4	NO.15	
PVC tube	2		



The whole printer assembly work is already done.

31 Warm tips

Before even attempting the first print it is vital that the printer is correctly calibrated. Skipping or rushing this step will result in frustration and failed prints later, “More preparation may quicken the speed in doing work .” so it is important to take the time to make sure the machine is correctly set up.

Each machine may have its own calibration procedure and this manual will not attempt to cover all the variations. Instead here is a list of key points that should be addressed.

- Frame is stable and correctly aligned.
- Rods are correctly aligned
- Belts are taut.
- Driving wheel turns smoothly
- Bed is level in relation to the path of the extruder.
- Filament rolls freely from the spool, without causing too much tension on the extruder.
- Current for stepper motors is set to the correct level.
- Wires are correctly connected
- Couplings and pulleys are fixed tightly

Firmware settings are correct including: axis movement speeds and acceleration; temperature control; end-stops; motor directions.

Extruder is calibrated in the firmware with the correct steps per mm of filament.

The point regarding the extruder step rate is vital. Slic3r expects that the machine will accurately produce a set amount of filament when told to do so. Too much will result in blobs and other imperfections in the print, too little will result in gaps and poor inter-layer adhesion. For how to set up the printer, please visit:

To know how to set up, please refer to the user manual.