

# Building Instructions of Geeetech Prusa I3 X

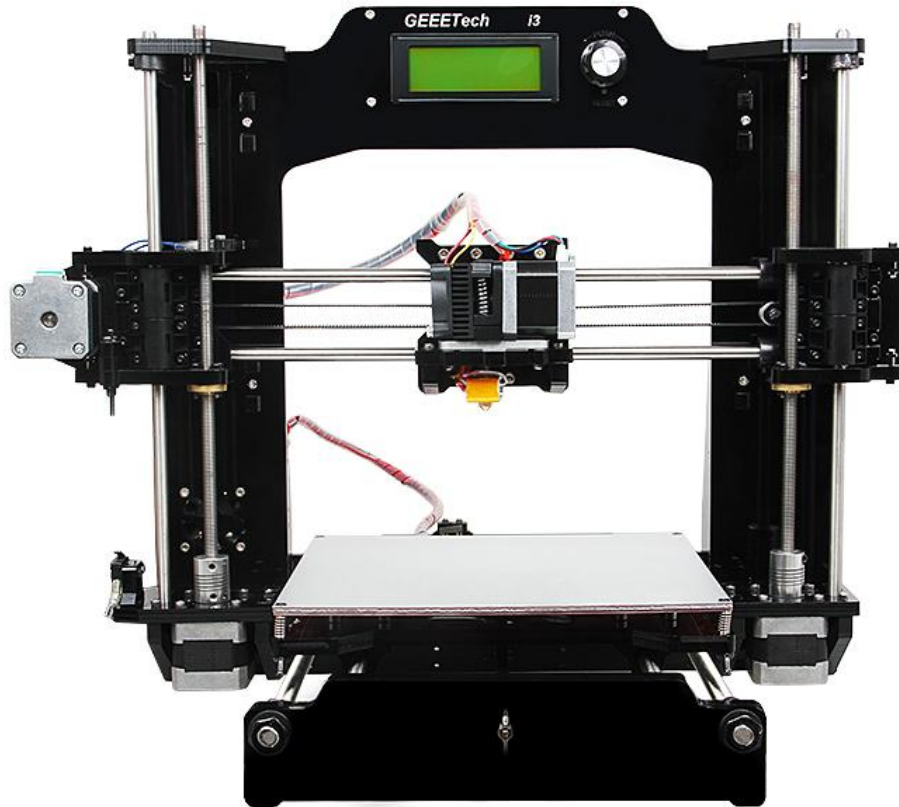

(Version 01-22-2016)

# CONTENT

Safety Instructions.....	3
Preparation .....	4
Unfold the box and check the package list.....	1
1. Assemble the threaded rods of Y axis .....	2
2. Assemble the front and back support of y axis.....	3
3. Mount the Y motor .....	5
4. Belt driving wheel.....	8
5. Build the print platform.....	15
6. Mount the Y belt.....	19
7. Left Z motor mount.....	20
8. Right Z motor mount.....	24
9. Side panel assembly .....	27
10. Main frame assembly .....	28
11. Fan mount .....	30
12. Assemble the Z motors.....	30
13. Assemble the left end of the X axis ( motor end).....	32
14. Assemble the right end of the X axis. (X idler).....	44
15. Assemble the extruder carriage .....	51
16. Assemble the the X&Z axis .....	55
17. Assemble the X motor.....	57
18. Add the belt.....	58
19. Mount the extruder.....	61
20. Mount the LCD panel .....	62
21. Mount the control board.....	64
22. Mount the building platform.....	65
23. Mount the Y endstop .....	66
24. Mount the power supply unit (PSU ) and the socket.....	67
25 Wiring .....	72
Step1. Check the subdivision of stepper motor .....	73
Step2. Plug stepper motor driver .....	74
Step3. Connect wires for motors. 1) Connect wires for X-axis motor.....	76
Step4. Connect heating wires.....	78
Step5. Connect wires for thermistor.....	80
Step6. Connect wires for endstop. 1) Connect wires for endstop of X-axis at X-Min....	82
Step7. Connect wires for Fan. 1) Connect fan for control board at FAN3.....	83
Step8. Connect wires for LCD panel.....	85
Step9. Connect wires for power input.....	86
Step 10. Connect the wires to the PSU.....	87
26. Mount the filament spool.....	87

## **Safety Instructions**

Building the printer will require a certain amount of physical dexterity, common sense and a thorough understanding of what you are doing. We have provided this detailed instruction to help you assemble it easily.

However ultimately we cannot be responsible for your health and safety whilst building or operating the printer, with that in mind be sure you are confident with what you are doing prior to commencing with building or buying. Read the entire manual to enable you to make an informed decision.

Building and operating involves electricity, so all necessary precautions should be taken and adhered to, the printer runs on 12V supplied by a certified power supply, so you shouldn't ever have to get involved with anything over 12V but bear in mind there can still be high currents involved and even at 12V they shouldn't be taken lightly.

High temperatures are involved with 3D Printing, the Extrusion nozzle of the hot end can run about 230 °C, the heated bed runs 110 °C and the molten plastic extruded will initially be at around 200 °C, so special care and attention should be made when handling these parts of the printer during operation.

We wouldn't recommend leaving your printer running unattended, or at least until you are confident to do so. We cannot be held responsible for any loss, damage, threat, hurt or other negligent result from either building or using the printer.

## Preparation

1. Unpack the kit and check if all parts are in the box and check the condition of each part, there might be some damage during shipping. To help you with this, there is BOM in the box and each bag was labeled with part number.
2. Contact our customer service immediately by email or through the website if you find any missing or damaged parts. And on the bottom of the BOM, there is a signature of reviewer, please take a picture of it and attach the picture in your mail.
3. **Read through each chapter of these instructions to gain an over-all idea of what is involved and how long it might take, before starting on the work described. Or you can watch the video [here](#).**
4. Before you start, you can put all the part in order to save your time especially those screws and nuts. Do not mix them up.
5. Ensure you have the necessary skills to carry out the work, or enlist the help of someone who does.
6. Work on a big firm table or bench in a clean dry well-lit area.
7. This kit contains tiny parts; please keep them away from kids under 3.
8. Ask for help if you run into any problems - our contact details are on the website and we will always do our best to resolve any problems encountered.
9. If you find any problem about the videos, such the part number is wrong, please refer to this instruction, videos are just for reference, we may do some tiny changes.

### Unfold the box and check the package list



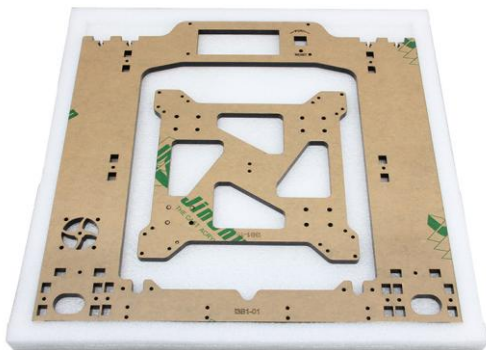

Unfold the package and take all the parts out to check the condition of the items.

\* All the acrylic plate has been etched with part ID and the plate is covered with a sheet of paper, you need to tear them off.

\* The part ID is corresponding to the number labeled on the bag of every part. Some parts may not have label, you can refer to the pictures on the package list.



**1. Assemble the threaded rods of Y axis**

Part name	Part ID	Required number	pic
450mm threaded rod	No.5	2	
M10 washer	No.9	8	
M10 hex nut	No.13	8	
M10 spring washer	No.10	6	
Connecting fender	No.A14	2	

Thread the nuts and washers into the two M10 threaded rods separately. The order should be:

1) Thread the acrylic fender (Y plate connecting plate) in the middle.

2) Thread the M10 washer>M10 nut >M10 nut >





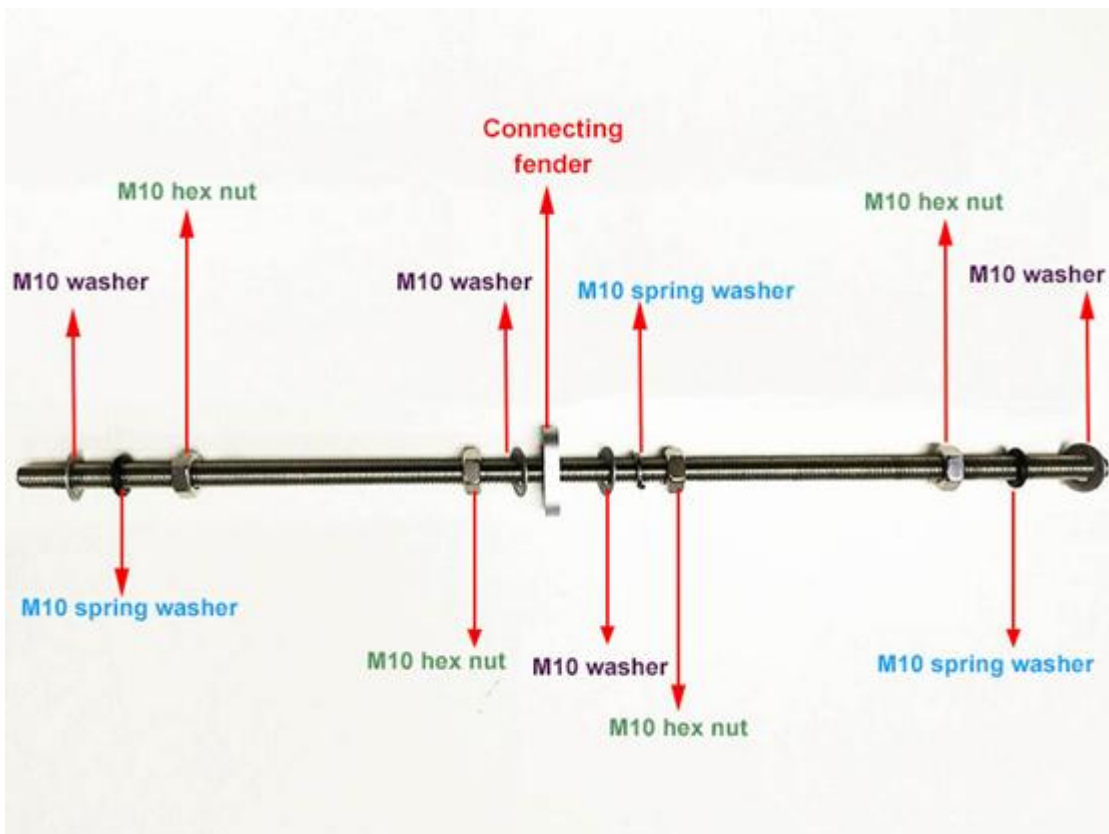

M10 nut <M10 nut < M10 spring washer<M10 washer in turn on the left

3) Thread theM10 washer < M10 spring washer < M10 nut < M10 nut< M10 spring washer < M10 washer in turn on the right



Watch the [Video](#) here.

## 2. Assemble the front and back support of y axis.

Part name	Part ID	Required number	pic
M10 washer	No.9	4	
M10 hex nut	No.13	4	
Y axis front support	No.A9	1	
Y axis front support	No.A10	1	
Y axis rear support	No.A11	1	
Y axis rear support	No.A12	1	

Thread the rod to the plate, screw up the threaded rods and plate with M10 nut and M10 washer at both end.

You don't have to tighten it because you need to adjust the distance between the front and rear plate later when you assemble the side panel.



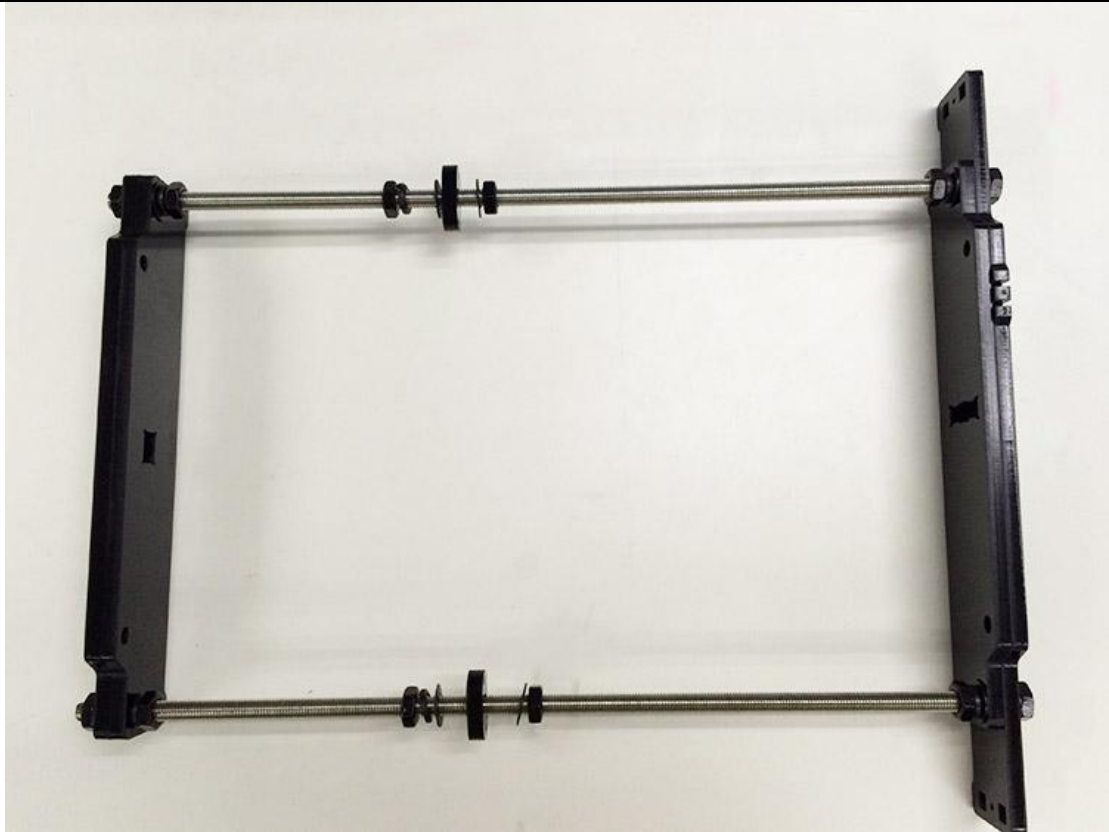

(this picture is just for reference, the plates are not exactly the same as that for I3 X)





\* Tips:

the Y-axis must be a rectangle, that is the rods on both side should be parallel, so is the front and back plate. Otherwise it will cause obstruction for the belt later. You can use a Digital Caliper to measure.

You can watch the video [here](#).

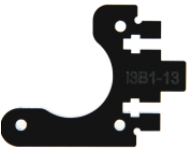
### 3. Mount the Y motor

Part name	Part ID	Required number	pic
stepper motor	No.63	1	

Y motor holder	No.A13	1	
M3 x12mm screw	No.22	3	
M3 x 20 mm screw	No.24	2	
M3 square nut	No.16	2	
Pulley	No.42	1	

Step1. Mount the pulley on the motor shaft, one of the screws should be screwed on the cross section of the shaft. Screw it tightly.

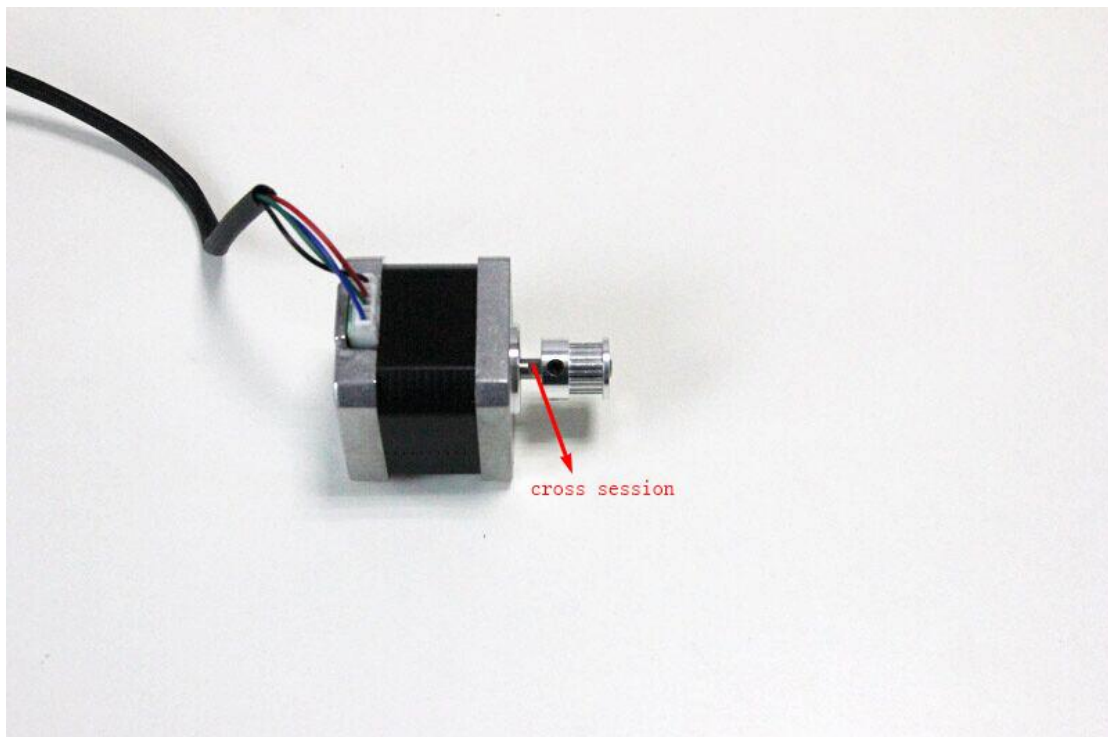

Step2. Then screw the motor on the block plate with 3 M3 x 12 screws .



Step3.Insert the motor holder into the slot; you may need to use a little strength to do this.





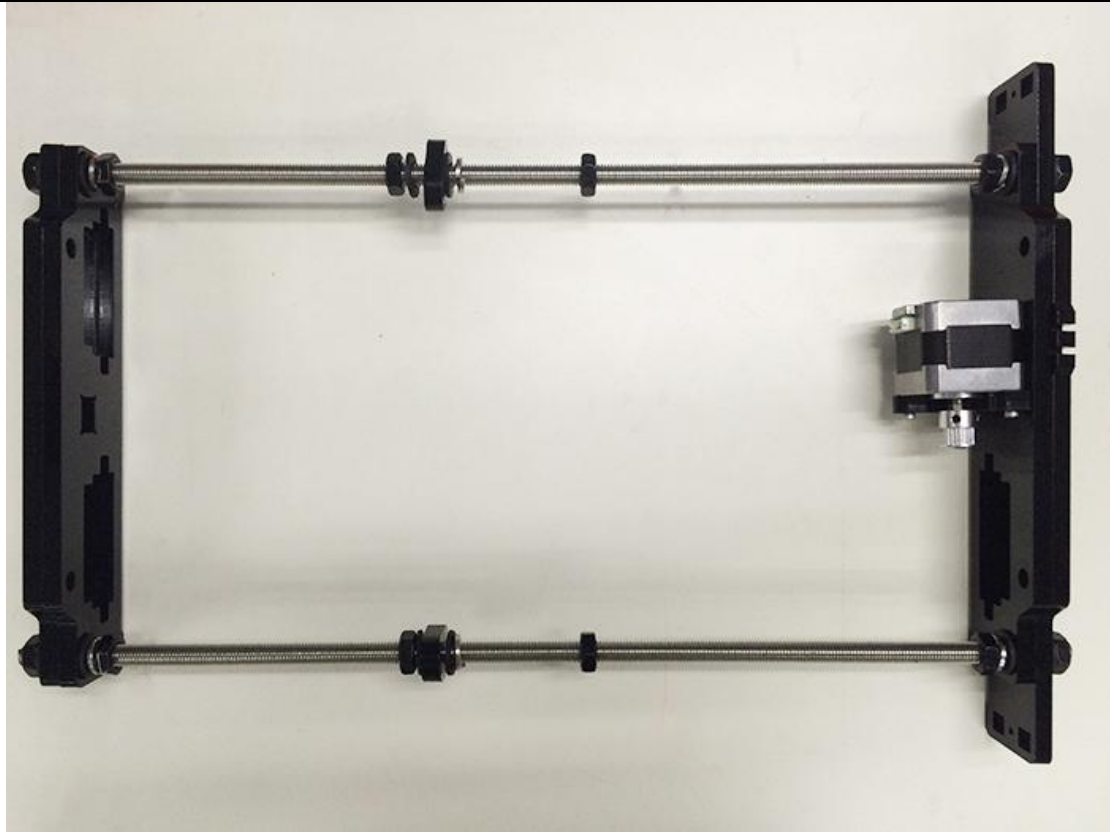

Fix the holder plate with 2 M3 x 20mm screws and M3 square nut.

**\*be careful in case the Acrylic break down.**



You can watch the video [here](#).

#### 4. Belt driving wheel

Part name	Part ID	Required number	pic
Driven wheel holder	No.40	1	
Ball Bearing	No.35	2	
Driving wheel	No.37	1	
M3 x20mm screw	No.24	3	
M4 x 25mm screw	No.31	2	
M4 locking nut	No.14	2	

wing nut	No.15	1	
----------	-------	---	---

Step 1. Thread the M3 x 20 screw through the top hole on the drive wheel holder.

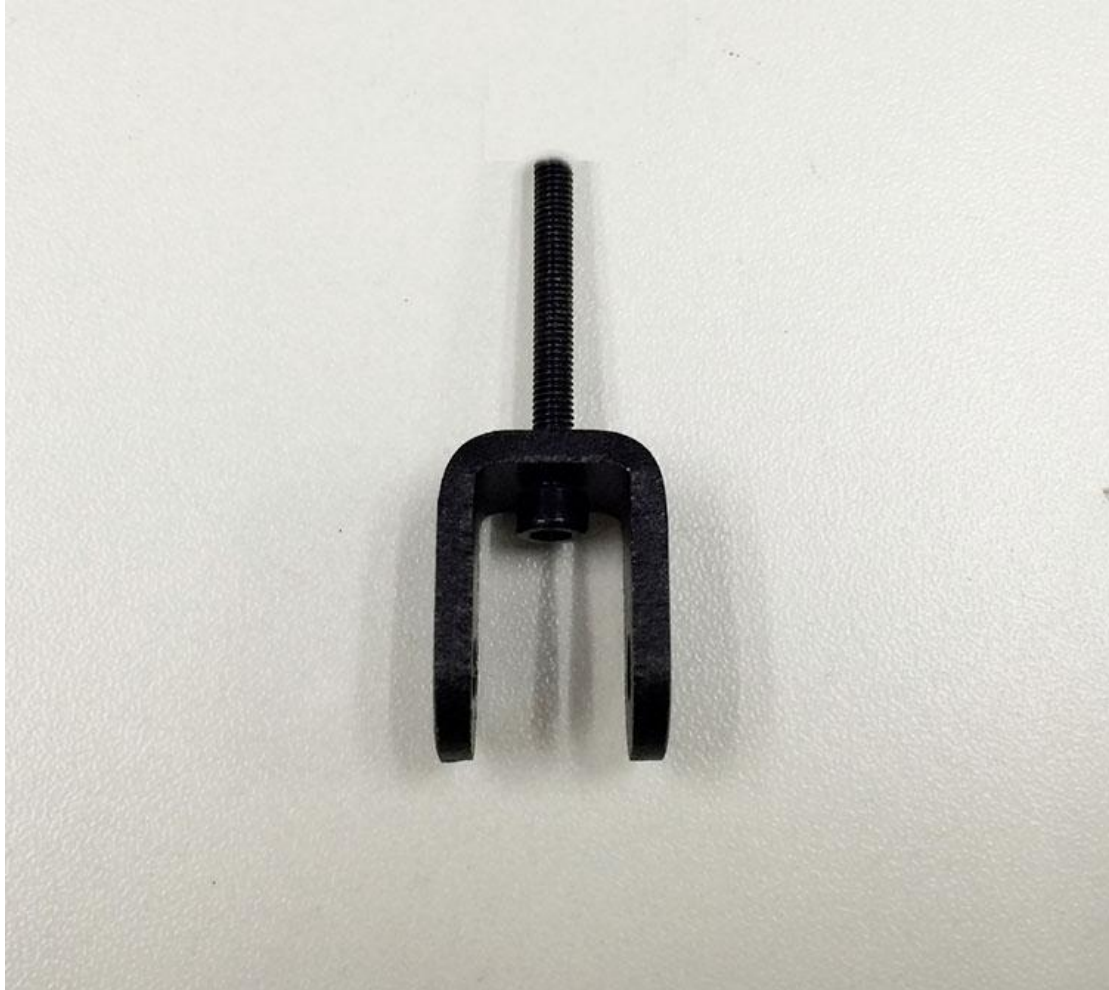

Step 2. Pick up 2 MR84zz ball bearings. Insert 1 MR84zz ball bearings into both ends of the drive wheel .

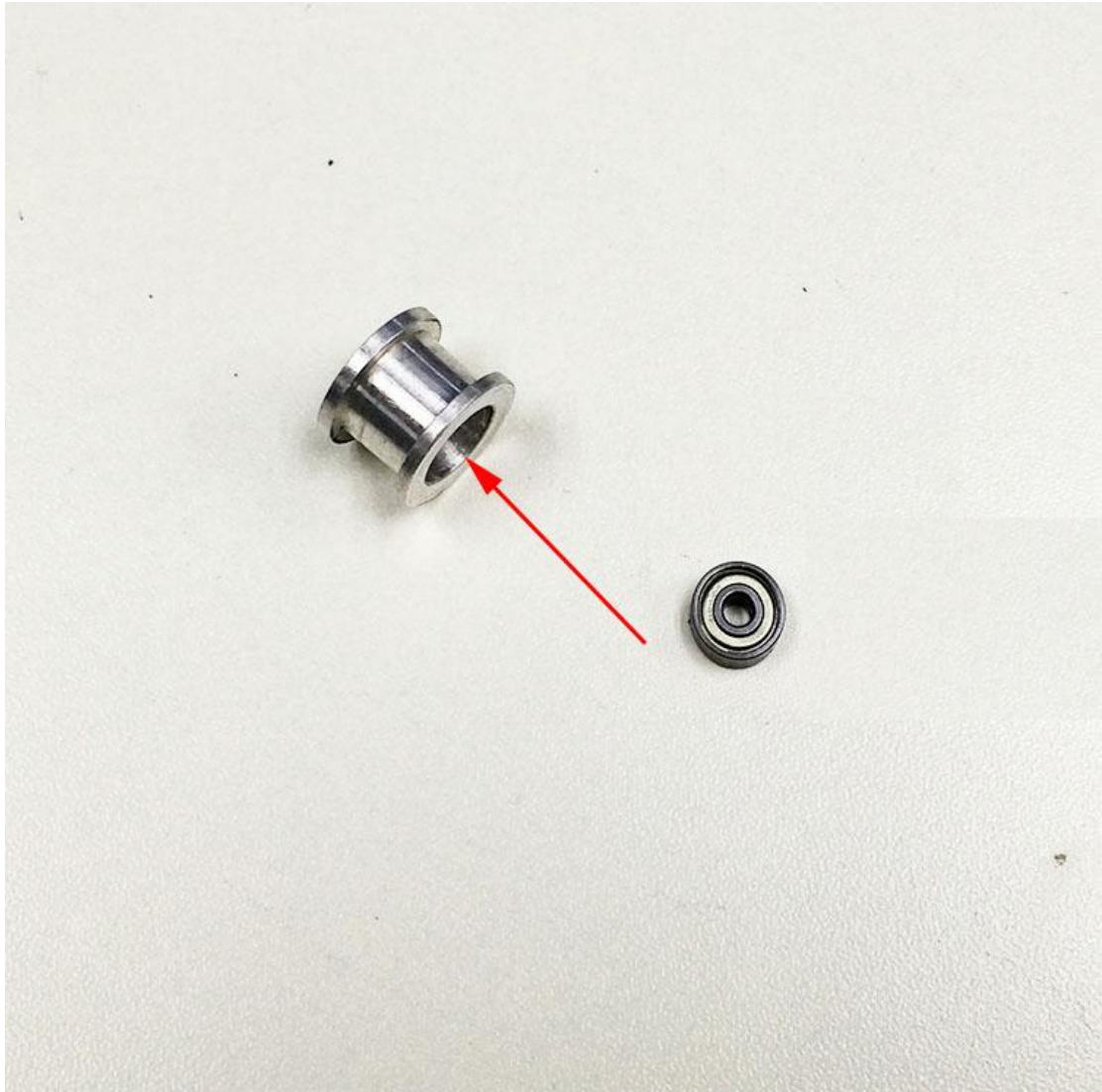



Step 3. Place the drive wheel in to the drive wheel holder and fix it in place with an M4 x25 screw and M4 washer. Lock the other end with a M4 lock nut . You may need a wrench to tighten M4 locking nut.







\*Note: Do not screw it too tightly as it may restrict the free movement of the drive wheel. It is important that you leave enough room for the wheel to turn freely.

Repeat the above steps to make another driving wheel using the M3x50mm screws instead for X axis belt driving.







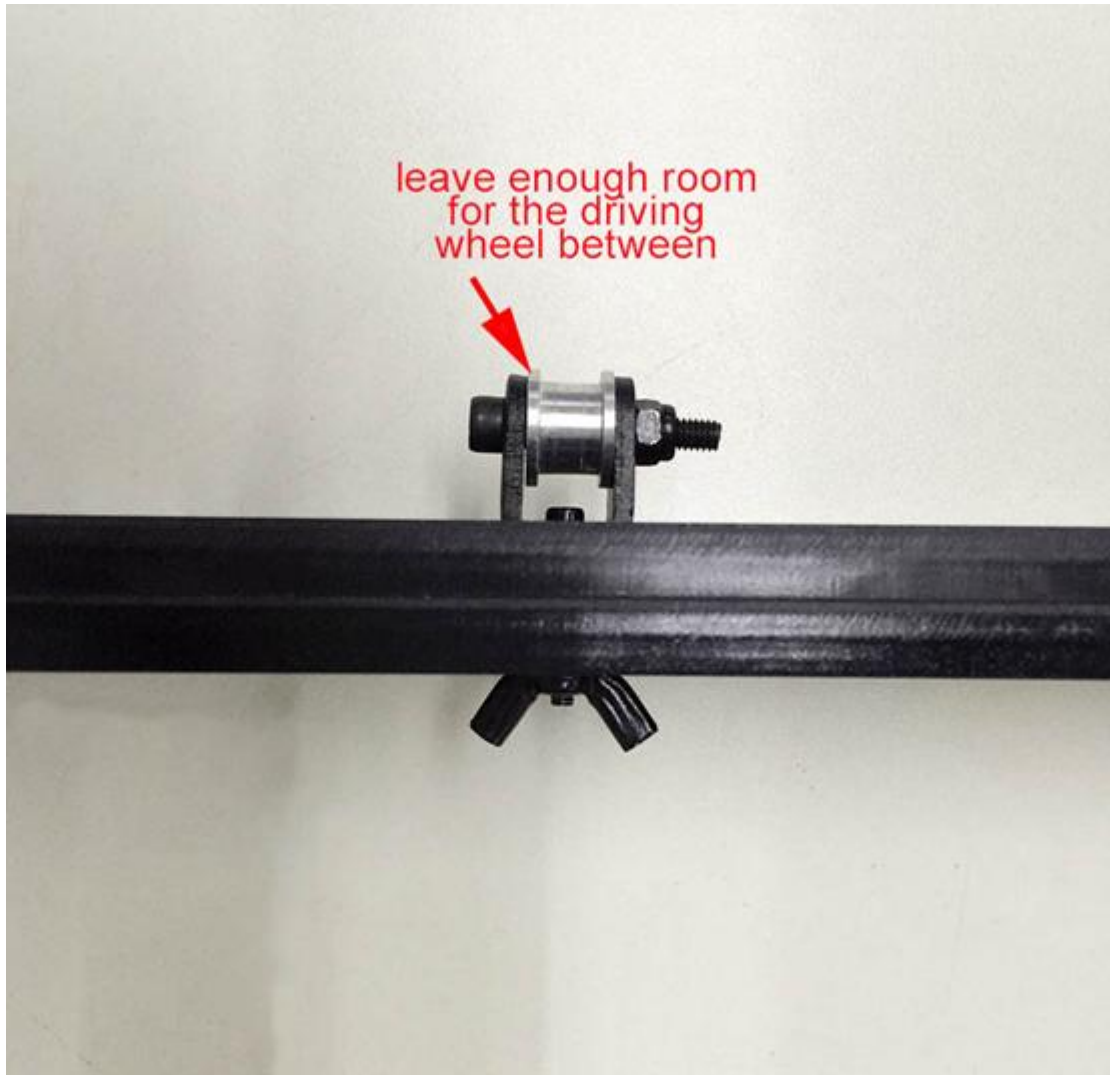





Watch the video [here](#).

Step3. Mount the assembled bearing holder onto the front support plates. And screw it with a wing nut later.



### 5. Build the print platform

Part name	Part ID	Required number	pic
Building platform support	No.A15	1	
Belt mount	No.41	1	
M4 x 16mm screw	No.30	16	

M4 washer	No.8	16	
PCS8UU linear bearing	No.36	4	
M3 x12mm screw	No.22	2	
M3 washer	No.7	2	
L420mm smooth rod	No.3	2	
locking ring	No.32	2	
M4Hex Nut	No.12A	16	

Step1. Mount the belt mount at the middle of the building platform support with two M3 x12mm screw and M3 washer.



Step 2. Mount the 4 PCS8UU linear bearings on the building platform support with M4x16mm screws and M4 hex nut.



Step3. Thread the L420mm smooth rod through the Y rear plate> thread a locking ring on the smooth rod> thread the building platform on the smooth rod through the PCS8UU linear bearings> thread the smooth rod to the Y front plate. Do the same with the other rod.

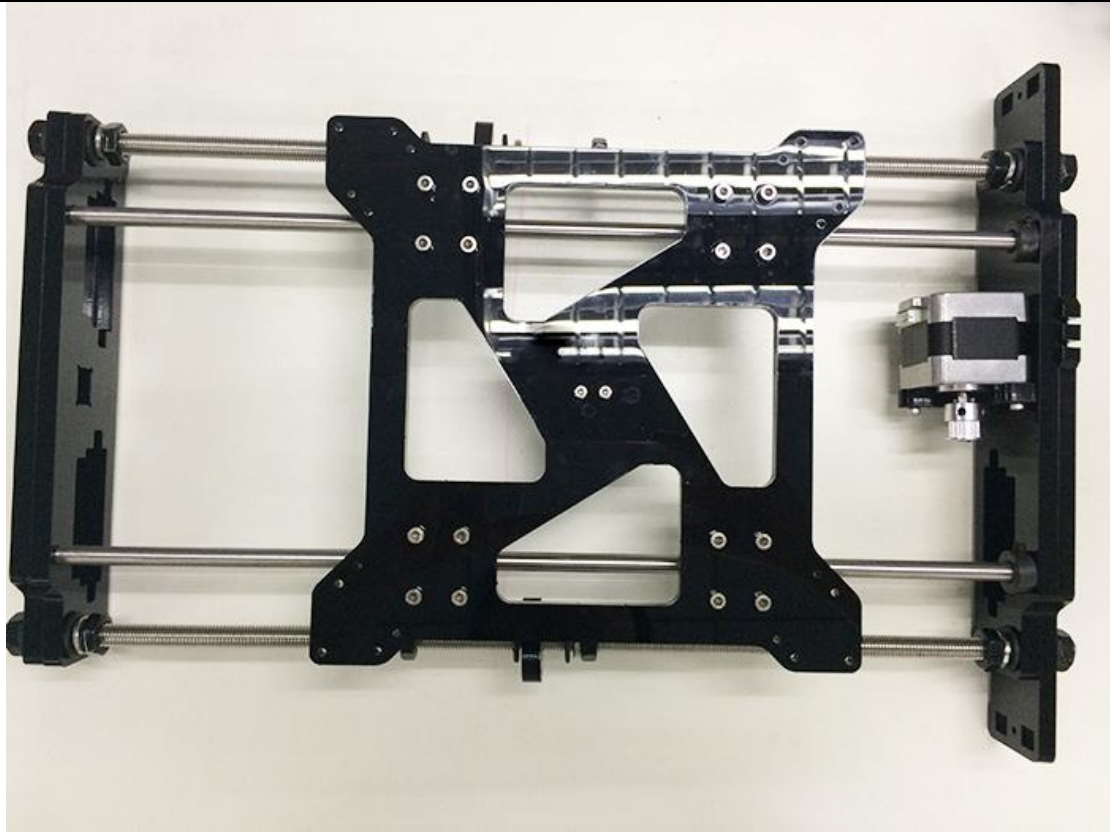



\* Note the direction of the building platform support, you can judge from the direction of the belt mount, whose direction is corresponding to the Y axis.

You can refer to the video [here](#).

(Linear Bearings in the video is different from this manual, but it will not affect your assembly, you can still finish it)

## 6. Mount the Y belt

Part name	Part ID	Required number	pic
Timing belt	No.39	1	
M3 x8mm screw	No.21	2	
M3 washer	No.7	2	

Step1. Punch a M2.5 hole on one end of the belt (the hole can be as the diameter of

the M2.5 screw , leave enough margin )

Step2. Fix the belt on one side of the belt -mount with a M3 x 8 screw and washer.

Step3. Thread the belt around the pulley on the motor and the ball bearing.





**(Linear Bearings in the video is different from this manual, but it will not affect your assembly, you can still finish it though)**

**\*Tips:**



1. Before you drill your second hole, make sure to pull belt tightly to make sure to proper placement of hole for a tight belt, if it is too loose, it will hinder the move of the print platform.
2. Loosen the Y idler wing nut when tightening belt onto the Y belt mount [No. 67] in order to make securing the belt to the block easier. Be sure to tighten wing nut fully once done.

Watch the video [here](#).

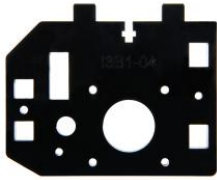
**7. Left Z motor mount**

Part name	Part ID	Required number	pic
M2.5 hex nut	No.11	2	
M2.5x16mm screw	No.20	2	
M3 x 16mm screw	No.23	6	
M3 Square nut	No.16	6	
end stop	No.52	1	
Motor holder (left)	No.A4	1	



Motor Holder support	No.A6	1	
Motor Holder support	No.A7	1	
Z endstop mount	No.A28	1	

Step1. Mount A6 to A4 with M3 x 16mm screw and M3 Square nut.

Step2. Mount A7to A4 with M3 x 16mm screw and M3 Square nut.

Step3. Mount the endstop on A28 with two M2.5 x 16mm screws and nut.

Step4. Mount the assembled endstop mount on the A4 with M3 x 16mm screw and M3 Square nut. (note the opening of the endstop)

Step5. Assemble the motor holder (left) and the motor holder support together, screw it up with 3 M3 x 16mm screw and M3 Square nut.

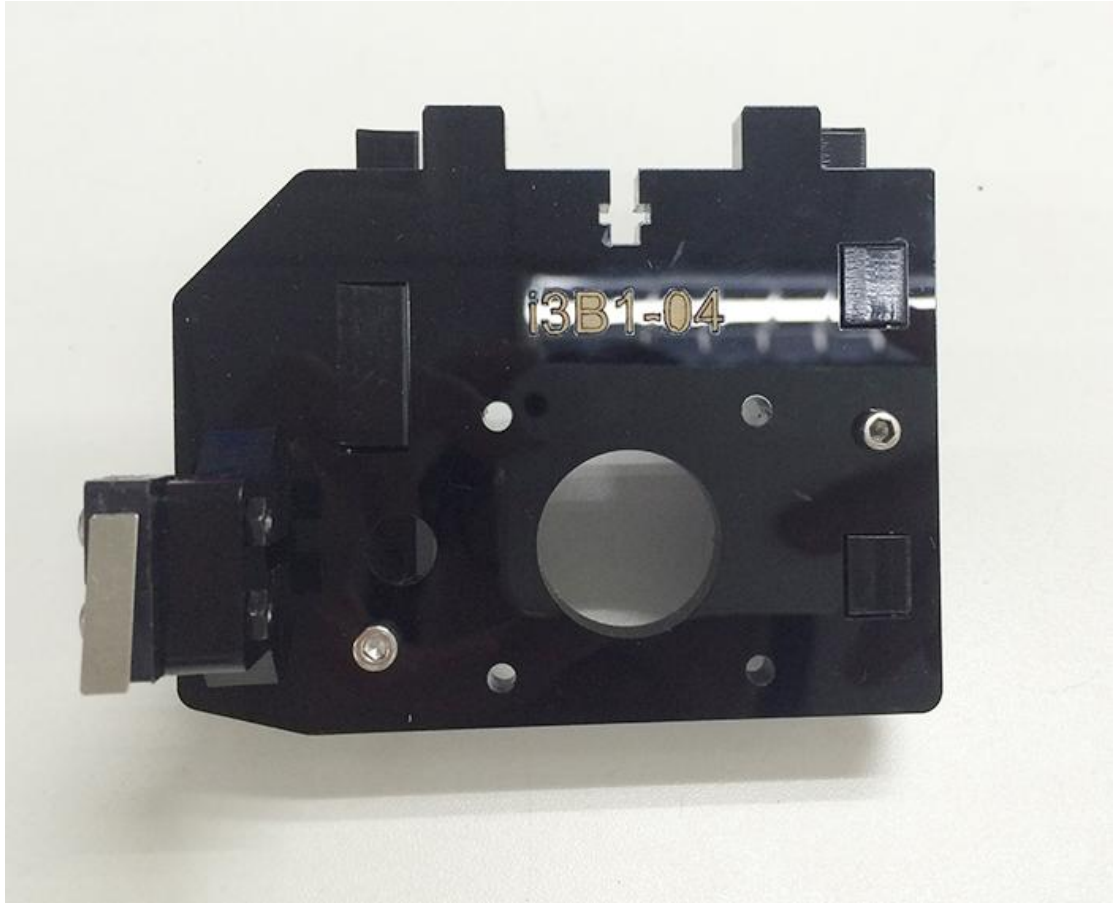



Step6. Insert the assembled left motor mount to the left-bottom of A1

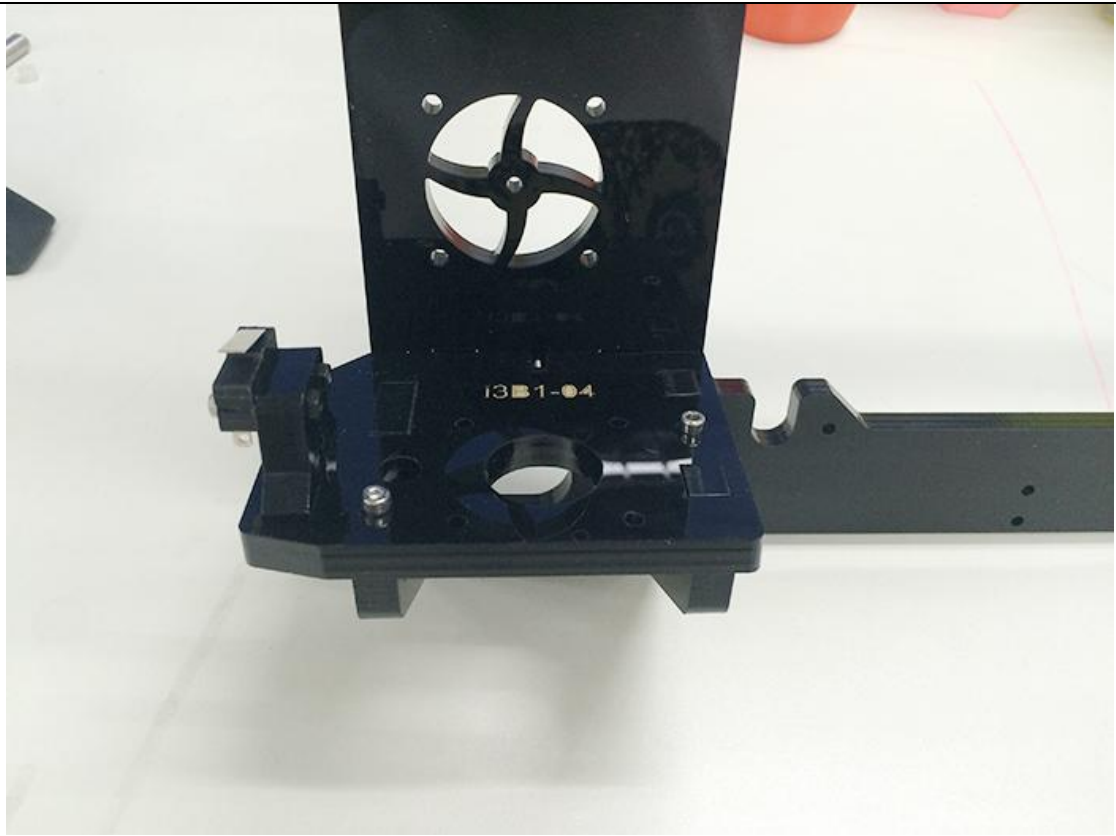

Mount the to assembled Z motor mount to A1 with M3 x 16mm screw and M3 Square nut.

\*Be very careful here, if you can not insert it into the hole, you can loose the screw on the motor mount and try again.



Watch the video [here](#).

### 8. Right Z motor mount

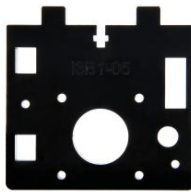
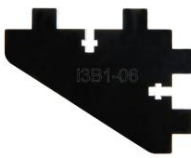
Part name	Part ID	Required number	pic
M3 x 16mm screw	No.23	5	
M3 Square nut	No.16	5	
Motor holder (right)	No.A5	1	
Motor Holder support	No.A6	1	

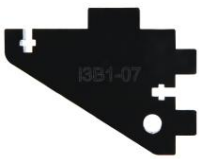
Motor Holder support	No.A7	1	
-------------------------	-------	---	---

Step1. Mount A7 to A5 with M3 x 16mm screw and M3 Square nut.

Step2. Mount A6 to A4 with M3 x 16mm screw and M3 Square nut.

Step3. Assemble the motor holder (right) and the motor holder support together, screw it up with 3 M3 x 16mm screw and M3 Square nut.

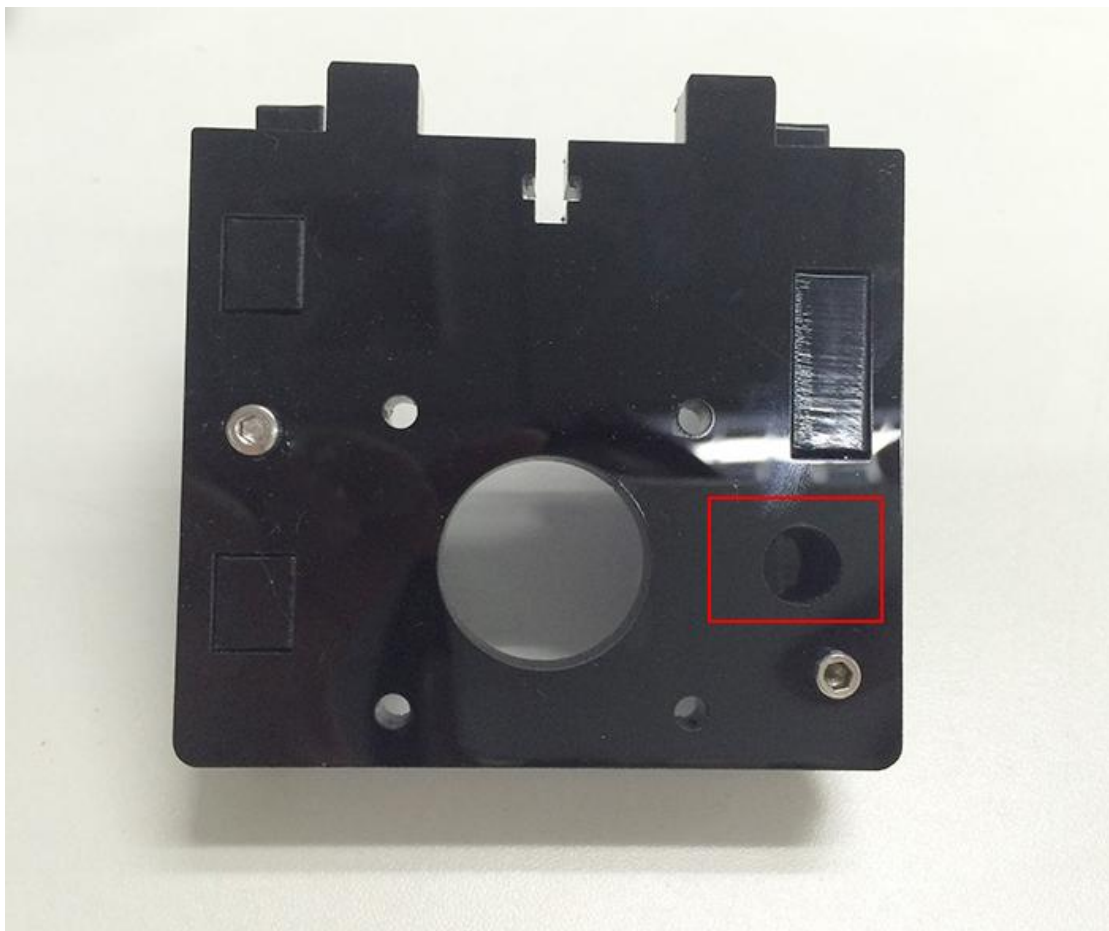



Step4. Insert the assembled left motor mount to the left-bottom of A1.

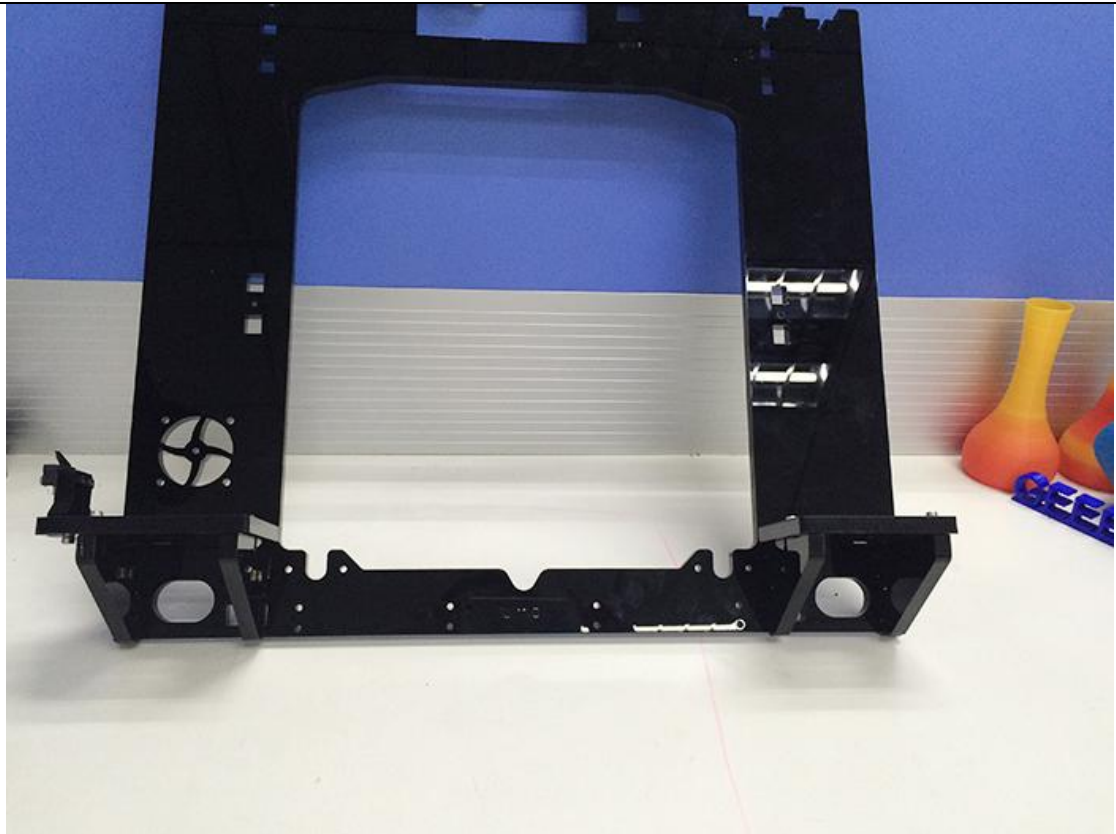

Mount the to assembled Z motor mount to A1 with M3 x 16mm screw and M3 Square nut.

**\*Be very careful here, if you can not insert it into the hole, you can loose the screw on the motor mount and try again.**



Watch the video [here](#).

### 9. Side panel assembly

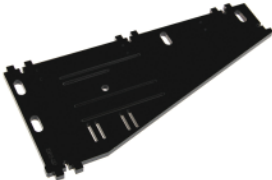

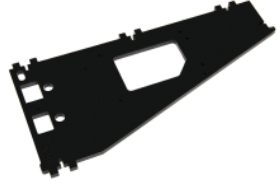

Part name	Part ID	Required number	pic
M3 x 16mm screw	No.23	6	
M3 Square nut	No.16	6	
M3 washer	No.7	6	
Side panel(left)	No.A2	1	

Side panel(right)	No.A3	1	
-------------------	-------	---	---

Fix the side panel on A1 with 6 M3 x 16mm screw, M3 Square nut and M3 washer.

Watch the video [here](#).

### 10. Main frame assembly

Part name	Part ID	Required number	pic
M3 x 16mm screw	No.23	2	
M3 x 20mm screw	No. 24	4	
M3 hex nut	No. 12	4	
M3 square nut	No.16	6	
M3 washer	No.7	4	

Step 1. Thread the assembled Y axis into the main frame(A1), put the main frame between the Connecting fender and the M10 nut. The Connecting fender is at the front part of the Y axis.

Step 2. Connect the side panel to the rear support plate, screw it up with M3 x 16mm screw and M3 square nut.



Step 3. Align the holes and Fix the connecting fender to A1 with M3 x 20mm screw and M3 hex nut.

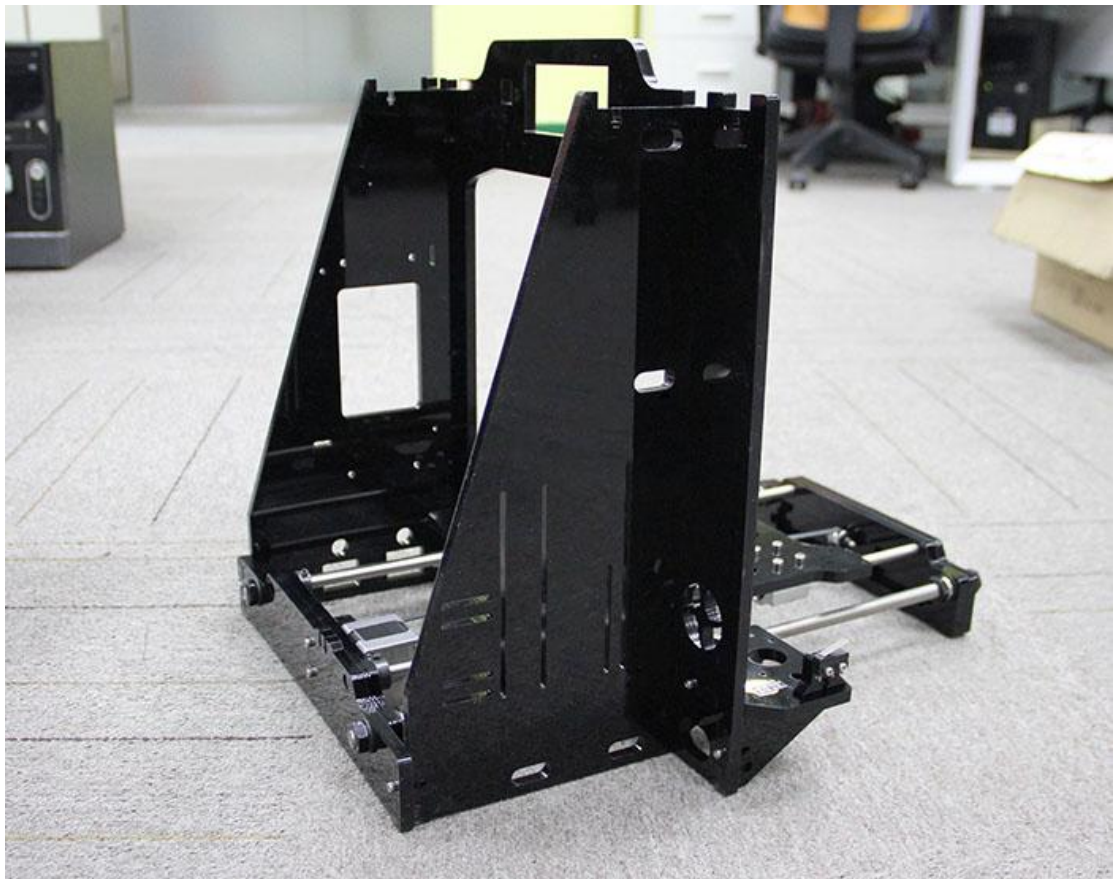
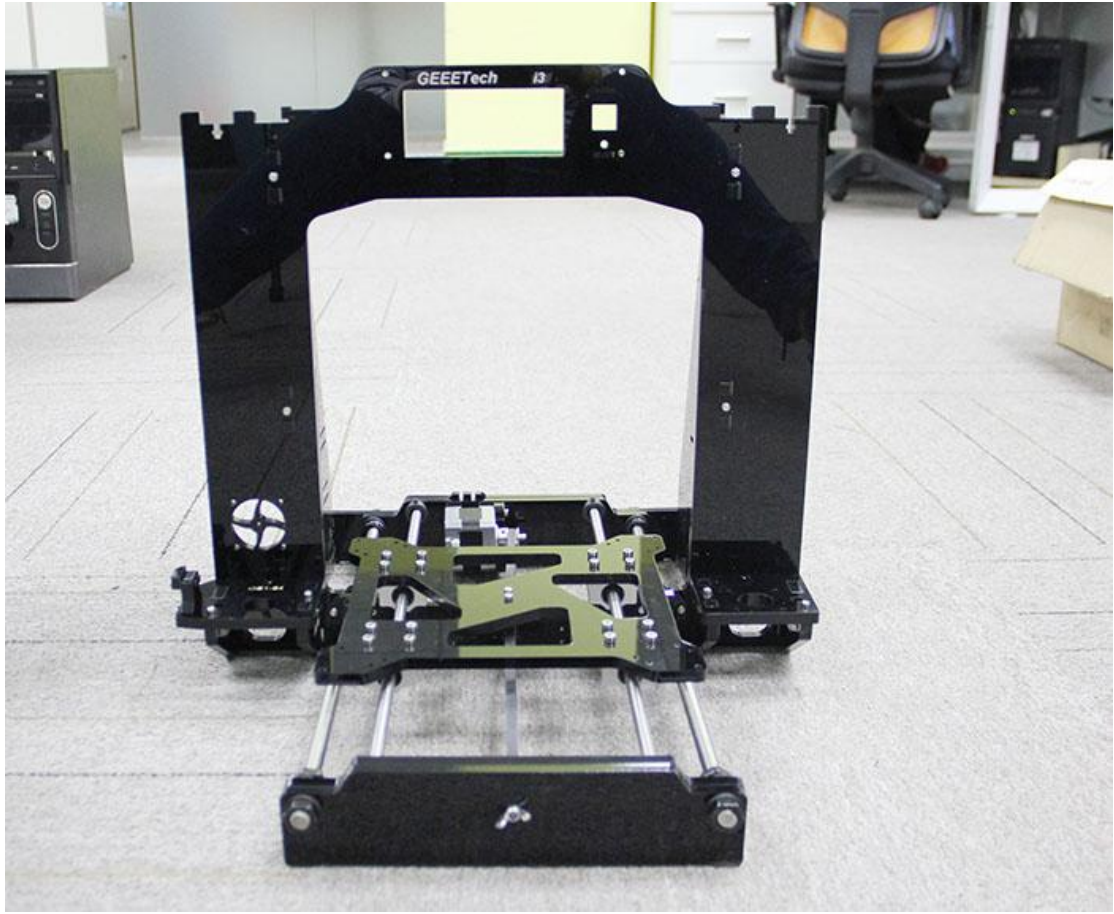



Watch the video [here](#).

### 11. Fan mount



Part name	Part ID	Required number	pic
M3 x 25mm screw	No. 25	4	
M3 hex nut	No. 12	4	
Fan	No.56	1	

Mount the fan on the left back side of the A1 with with M3 x 25mm screw and M3 hex nut.



Watch the [video](#).

### 12. Assemble the Z motors

Part name	Part ID	Required number	pic
stepper motor	No.63	2	
M3 x12mm screw	No.22	8	
Coupling	No.38	2	

Step1. Fix the two couplings on the Z motor shaft separately.

Please note the opening of both end, one is 5mm, another is 8mm, connect the 5mm hole to the motor shaft. Screw it tightly.

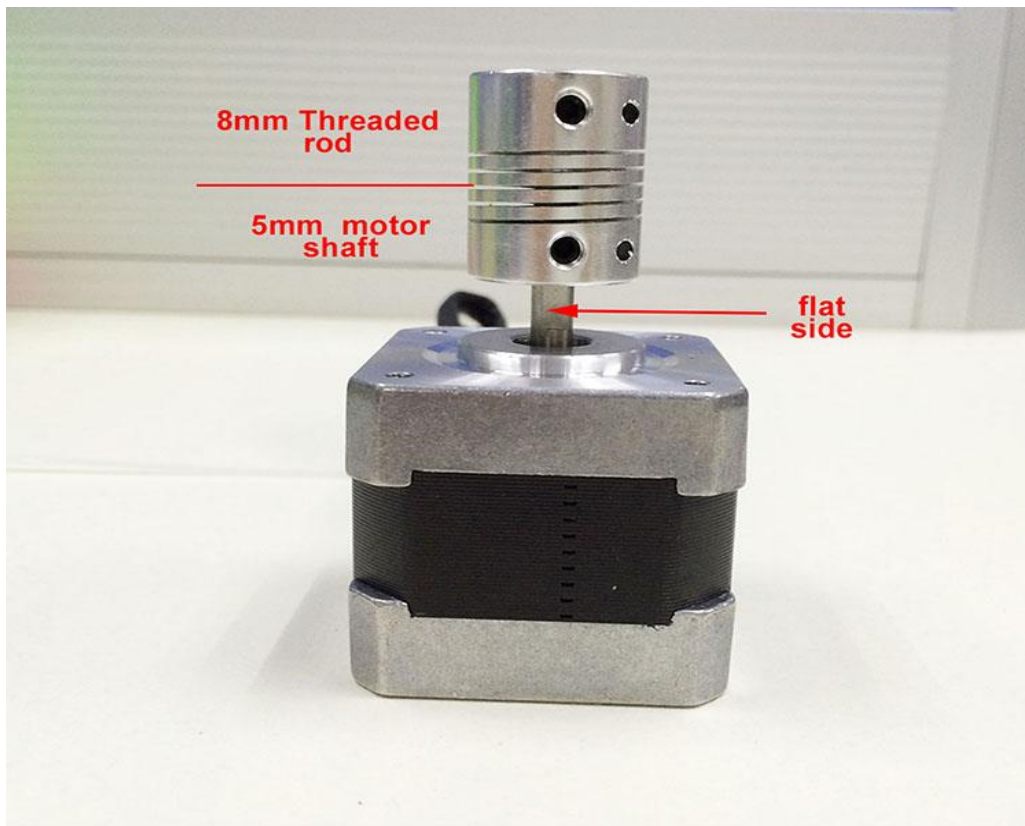

Step2. Mount the motor on the motor mount with 4 M3x12mm screws for each.

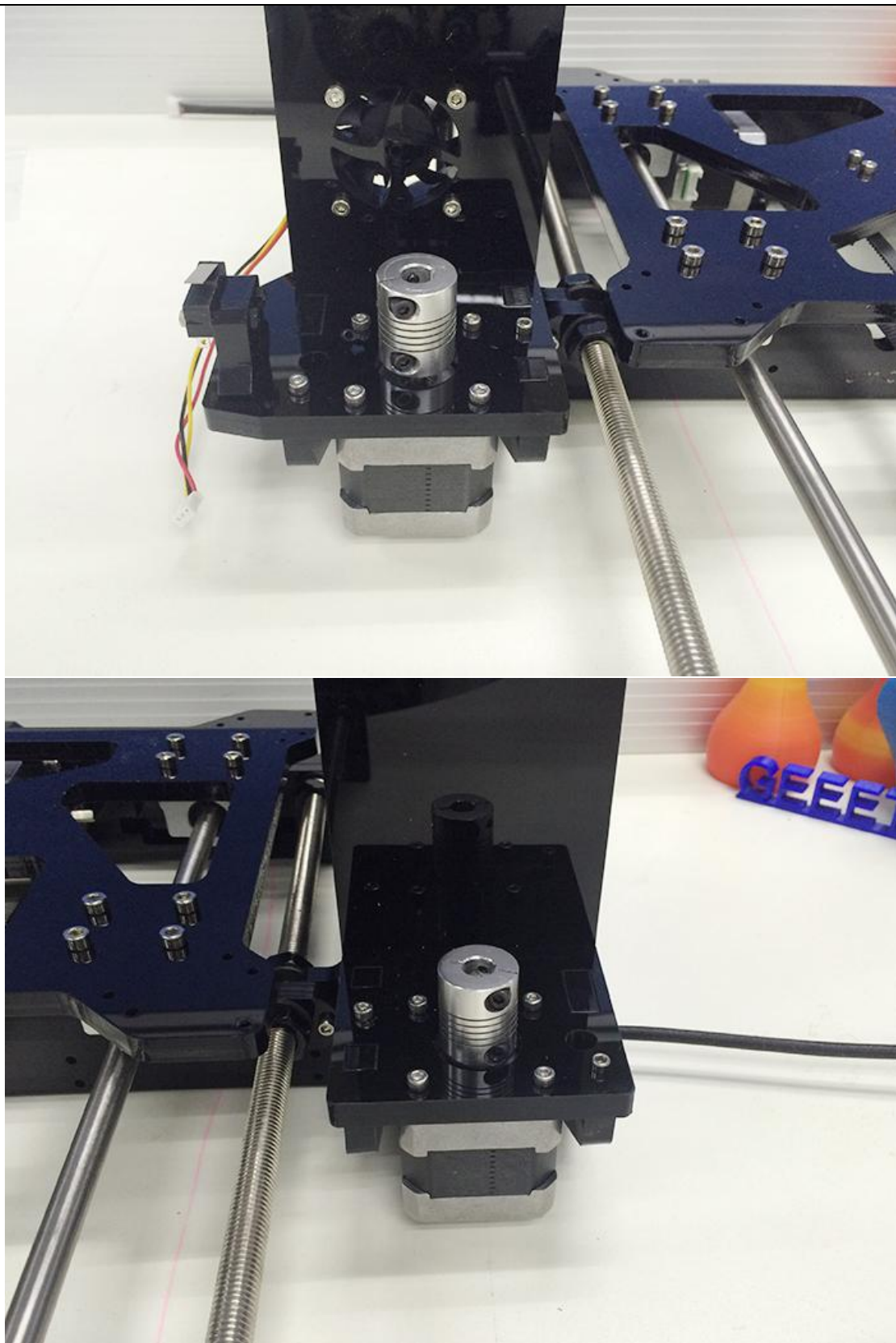

Watch the [video](#).





**13. Assemble the left end of the X axis (motor end)**

\* To help you see clearly, I didn't tear off the paper, but you need to tear it.

For the whole process of assembly of this part, please refer [here](#).

(Linear Bearings in the video is different from this manual, but it will not affect your assembly, you can still finish it)





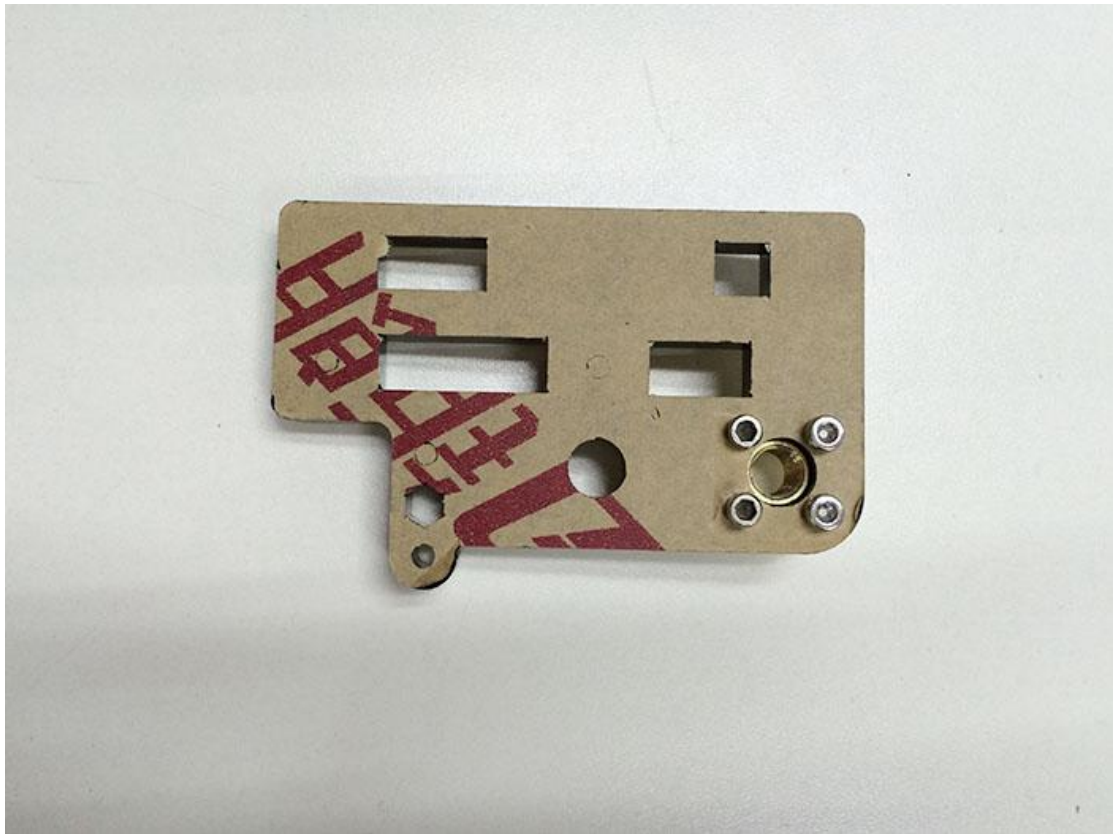

Step 1. Mount the Z-axis nut.

Part name	Part ID	Required number	pic
M3 x 16mm screw	No. 23	4	
M3 washer	No. 7	4	
Z-axis nut	No.17	1	
Left bearing bottom plate	No.A18	1	

Mount the Z nut on the A 18 from underside to up, fix with M3 x 16mm screw and M3 washer.



Step 2. Mount the endstop trigger.

Part name	Part ID	Required number	pic
M3 x 30mm screw	No. 26	2	
M3 x 50 screw	No.28	1	
M3 hex nut	No. 12	4	
Spring	No.34	1	
Endstop holder	No.A21	1	
Endstop holder	No.A22	1	

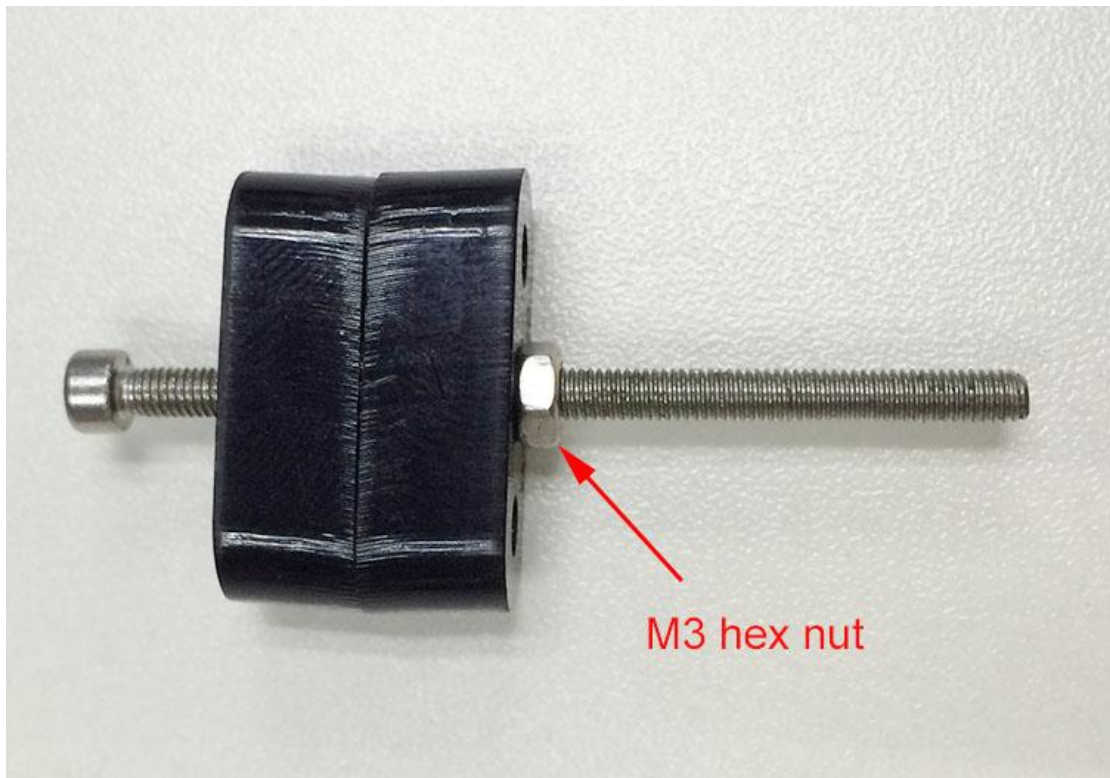
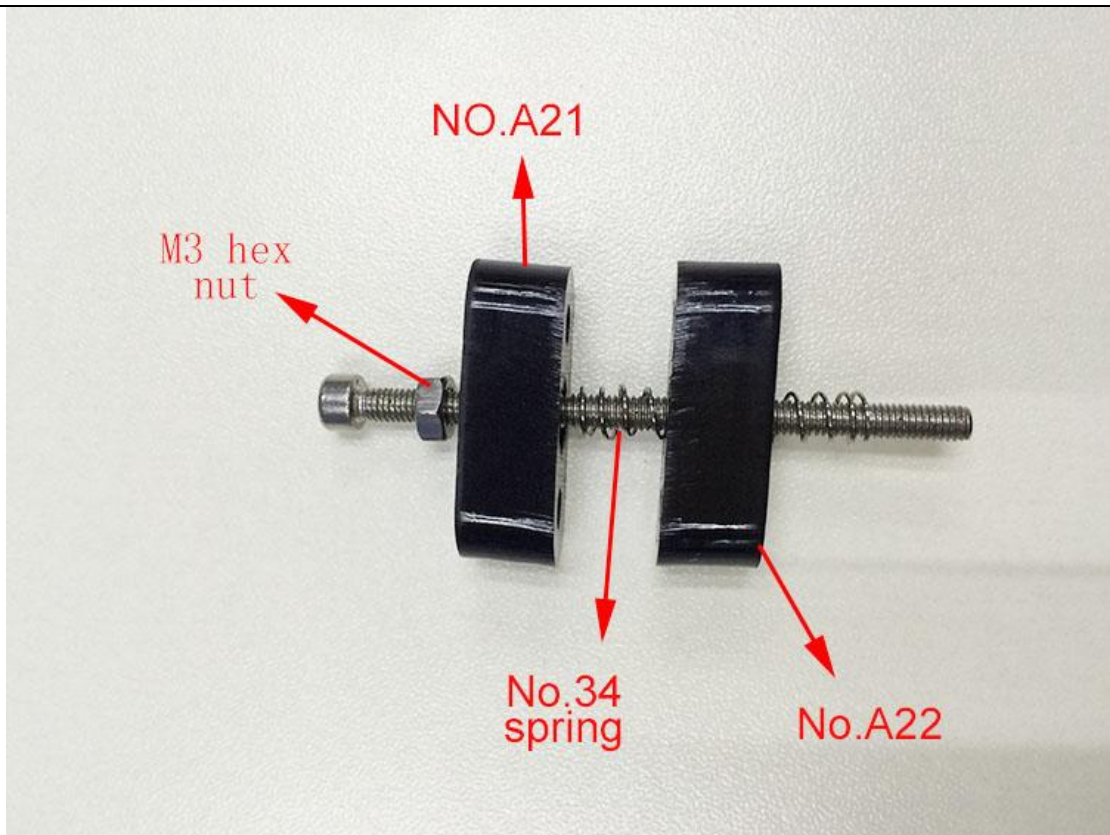

1. Thread a M3 hex nut to the M3 x 50 screw.
2. Thread the A21 to the M3 x 50 screw.
3. Thread the spring to the the M3 x 50 screw through the hole of A21.
4. Thread A22 to the M3 x 50 screw
5. Thread another M3 hex nut to the M3 x 50 screw, compress the spring into the M3 hex hole on A21 and A22, you need to use some force.
6. Mount them on the Left bearing bottom plate (No.A18 ).
7. Fix it up with 2 M3 x 30mm screws and M3 hex nuts.



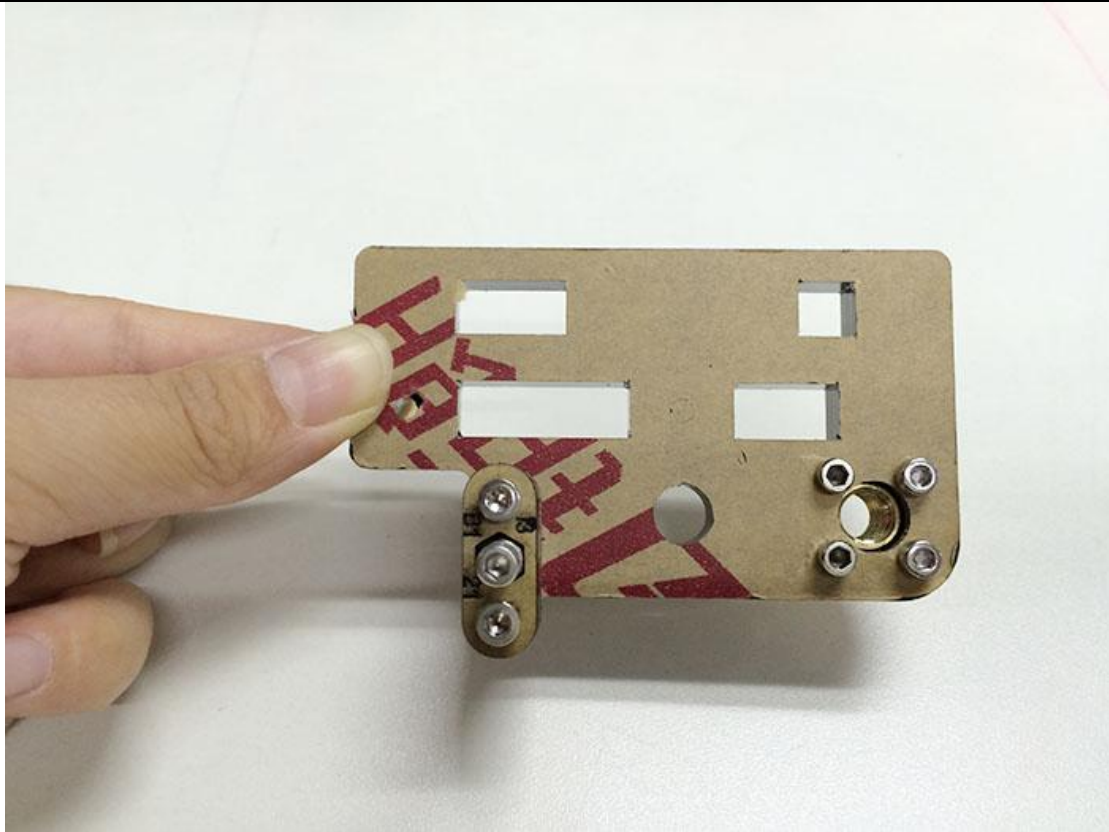





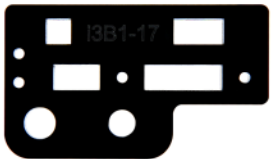

Step 3. Mount the endstop

Part name	Part ID	Required number	pic
M2.5 x 16mm screw	No. 20	2	
M2.5 hex nut	No. 11	2	
End stop	No.52	1	
Left bearing top plate	No.A17	1	

Mount the endstop on the Left bearing top plate with two M2.5 x 16mm screw and M2.5 hex nut



Step 4. Assemble the X left end together

Part name	Part ID	Required number	pic
M3 x 16mm screw	No. 23	8	
M3 Square nut	No. 16	8	
X motor holder	No.A 16	1	
X axis rod holder (left)	No.A 19	2	
X axis belt holder	No.A 20	1	

\* Note the direction

1. Mount the two A19 to A16 on the side without engraving.

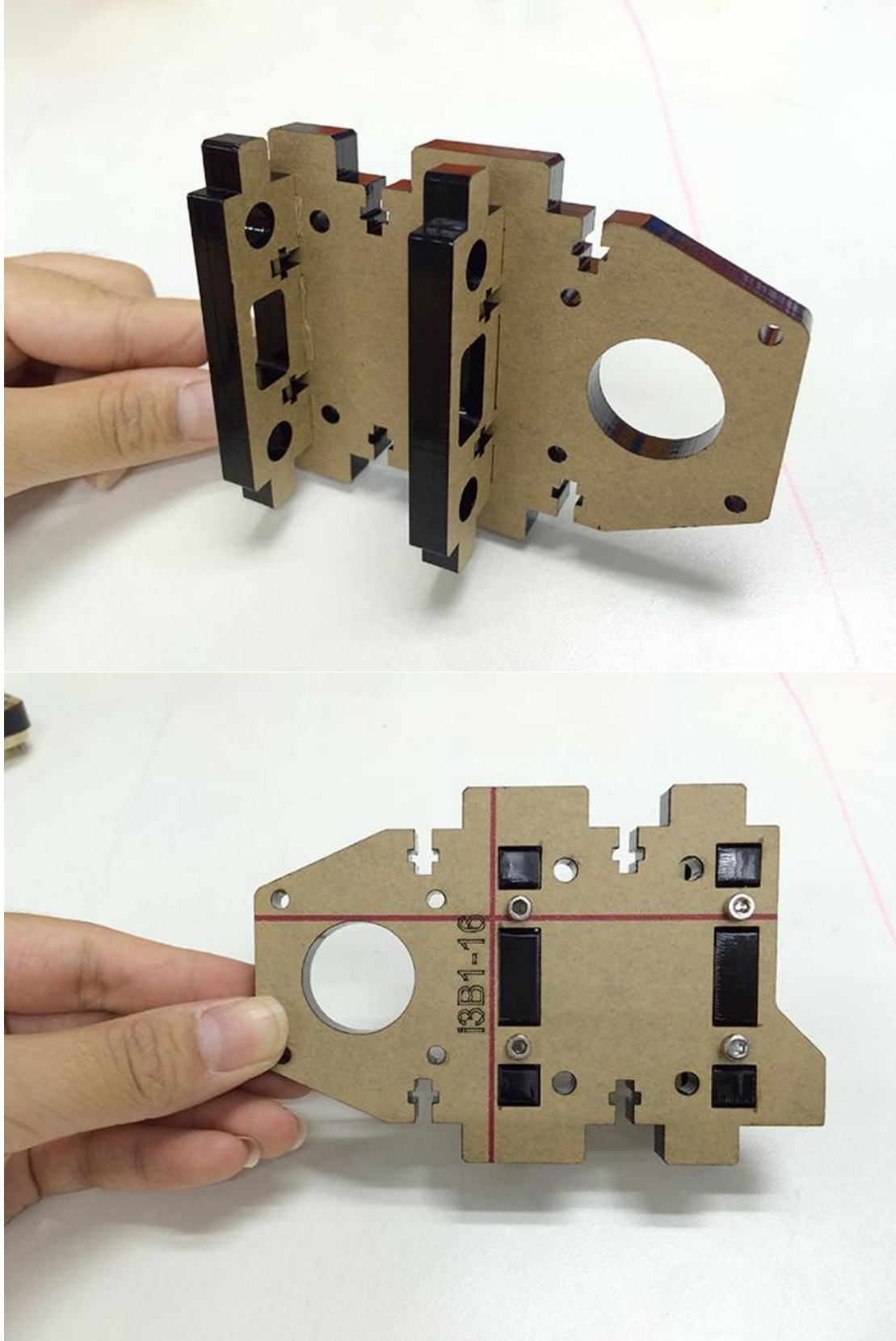

2.Add the top late

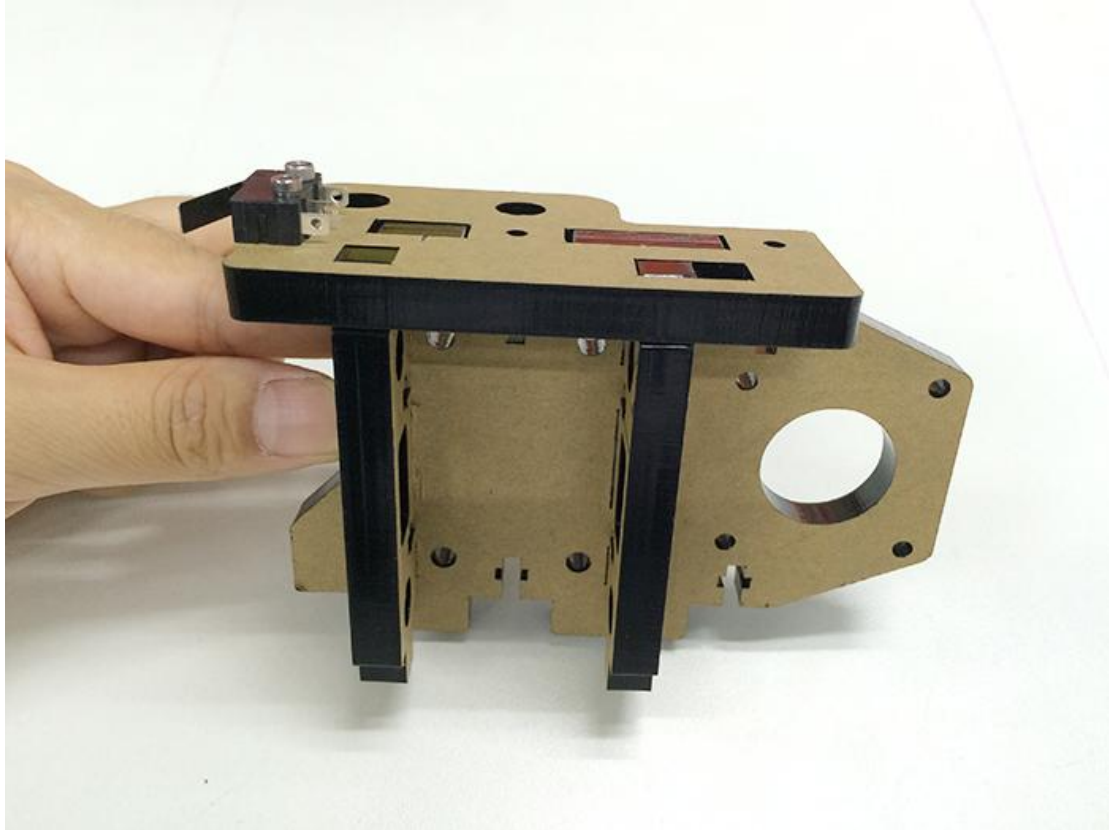



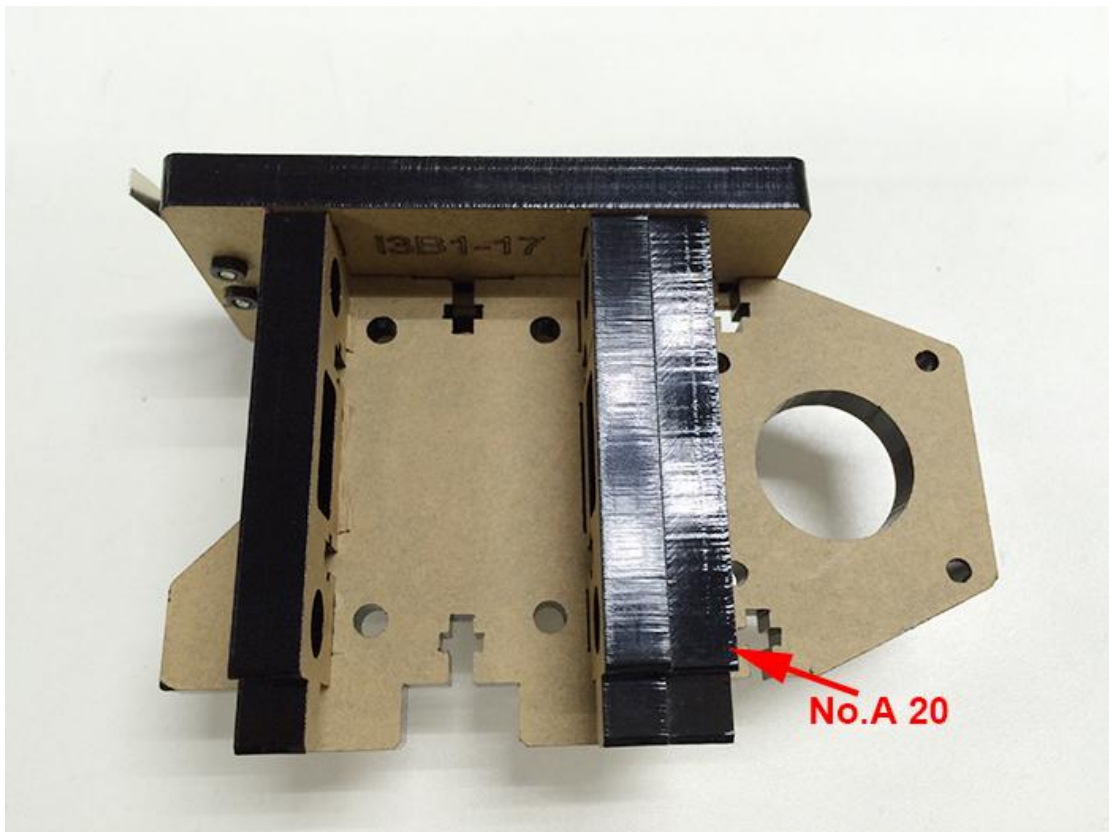

3.Add A20 beside the A19

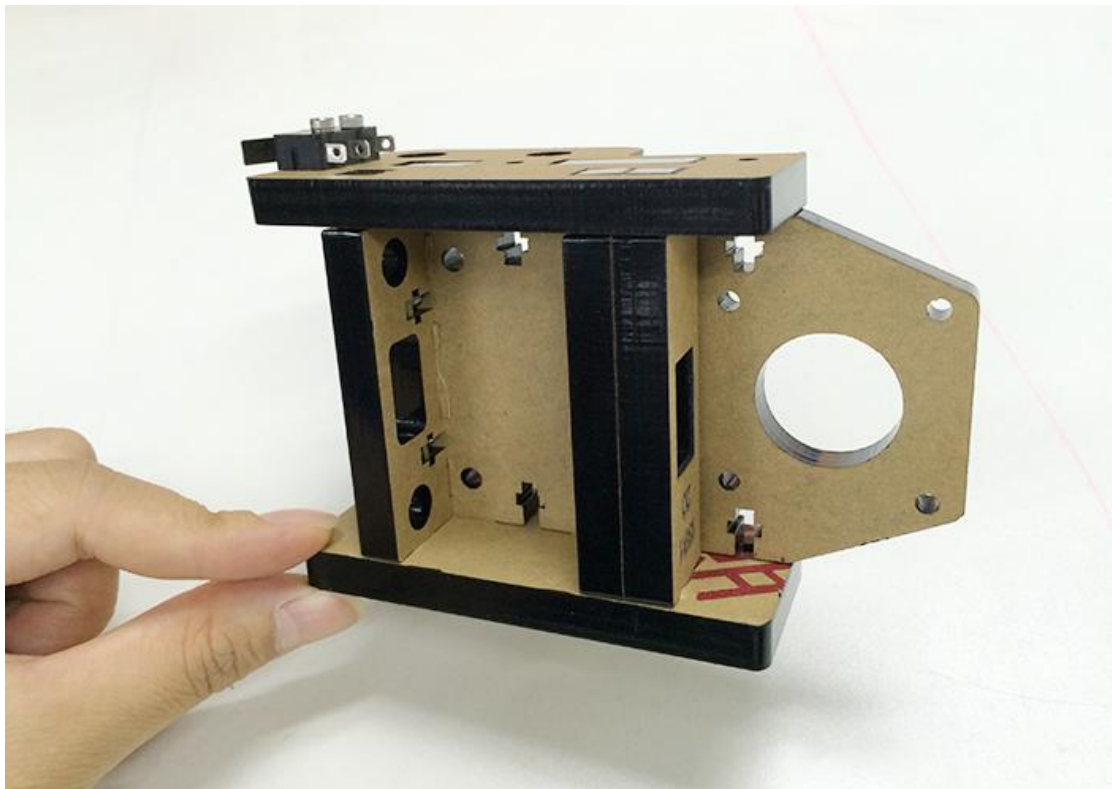
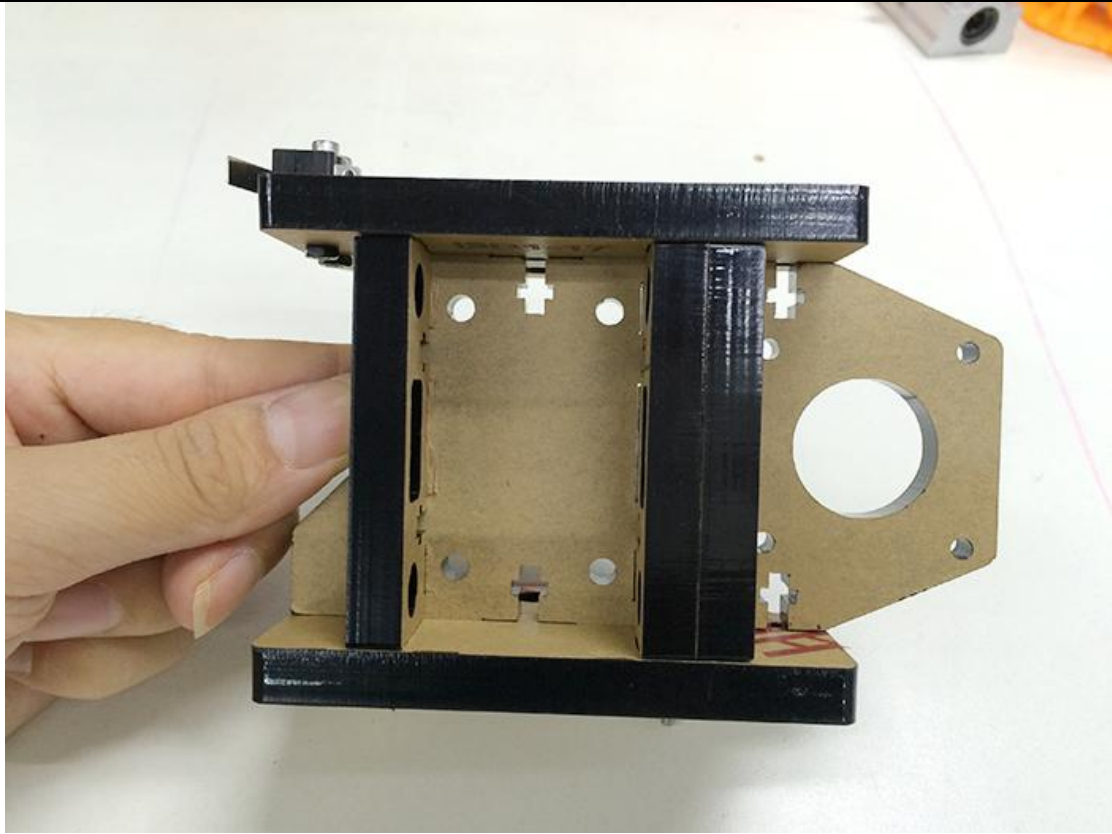

4.Add the bottom late



Step 5. Fix the linear bearing PCS8LUU.

Part name	Part ID	Required number	pic
linear bearing PCS8LUU	No. 32	2	
M4x16mm screw	No. 30	8	
M3 x 16mm screw	No. 23	4	
M3 Square nut	No. 16	4	
M4 hex nut	No. 12A	8	

Mount the PCS8LUU on X motor holder with M4x16mm screws and M4 nut. And fix the top and bottom plate with M3 x 16mm screw and M3 Square nut.

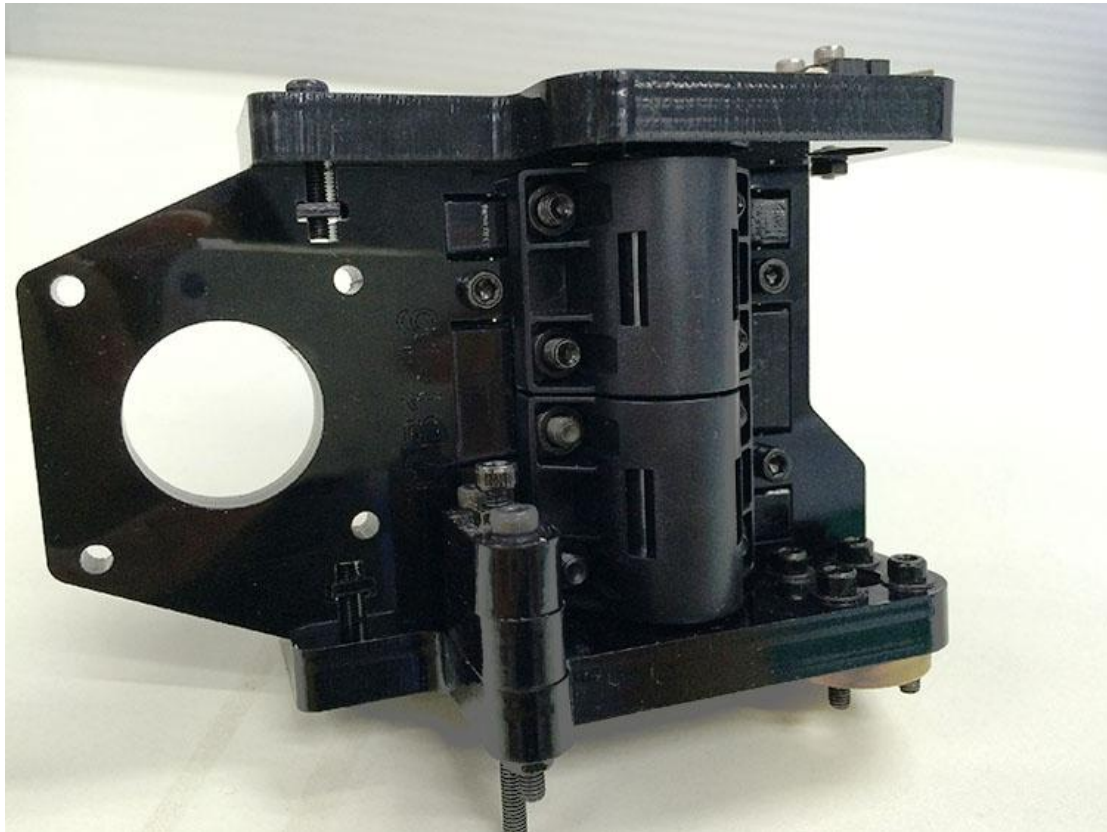

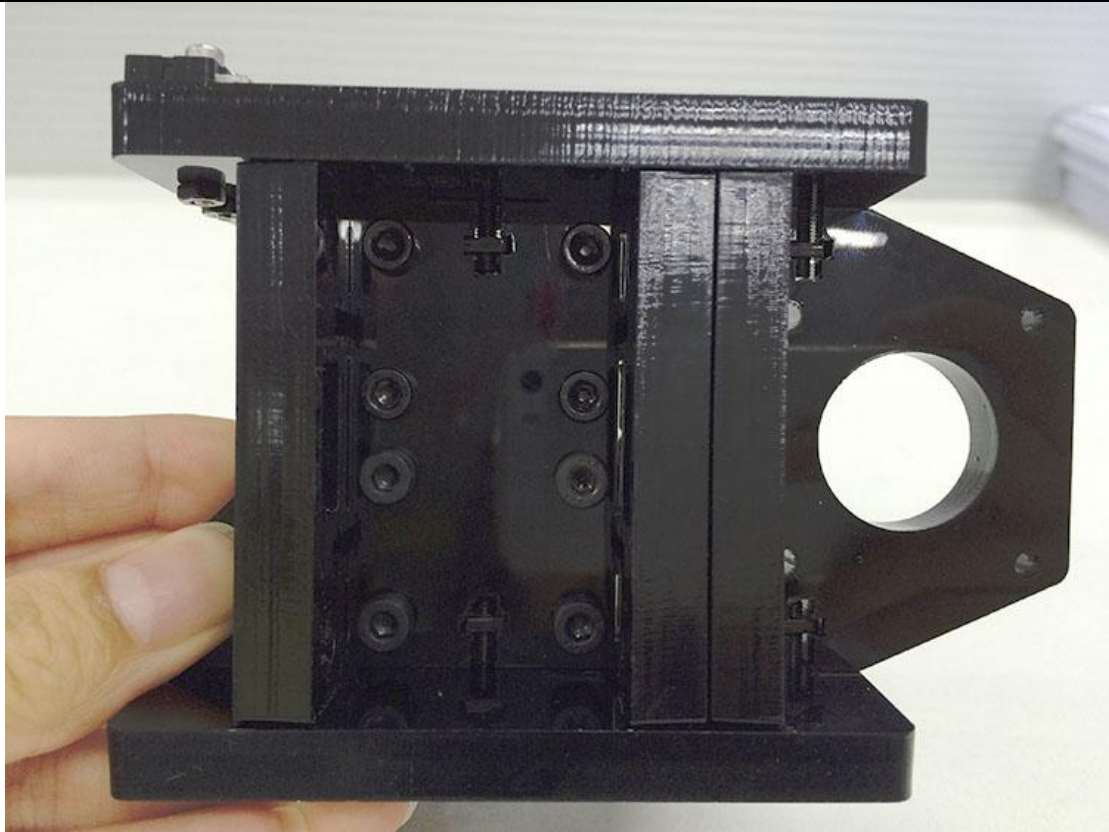



#### 14. Assemble the right end of the X axis. (X idler)

For the whole process of assembly of this part, please refer [here](#).

(Linear Bearings in the video is different from this manual, but it will not affect your assembly, you can still finish it)

Step1. Mount the Z axis nut

Part name	Part ID	Required number	pic
M3 x 16mm screw	No. 23	4	
M3 washer	No. 7	4	
Z-axis nut	No.17	1	







Right bearing top/bottom plate	No.A24	1	
-----------------------------------	--------	---	---

Mount the Z axis nut on A24 with 4 M3 x 16mm screw and M3 washer from underside to up..



Step2. Mount A25 and A26 on A23

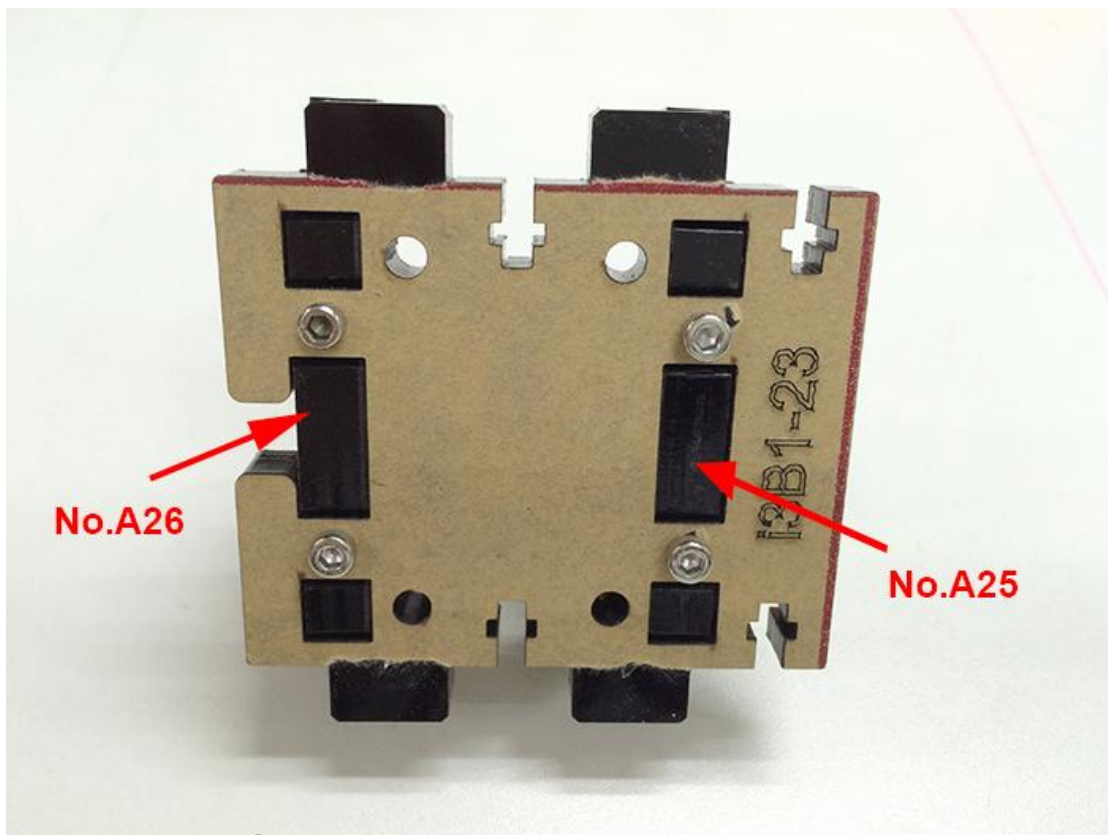

Part name	Part ID	Required number	pic
M3 x 16mm screw	No. 23	4	
M3 Square nut	No. 16	4	
Right bearing holder	No.A23	1	

X axis rod holder(right)	No.A25	1	
X axis driving wheel support holder	No.A26	1	

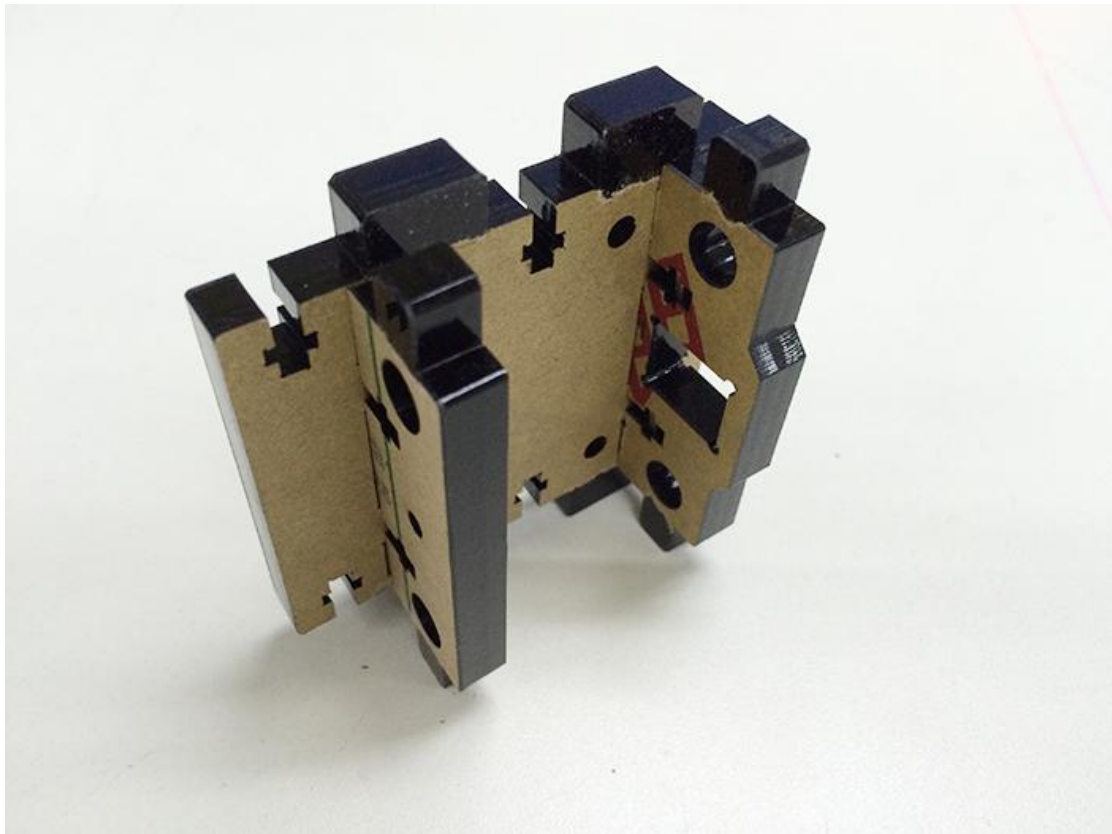
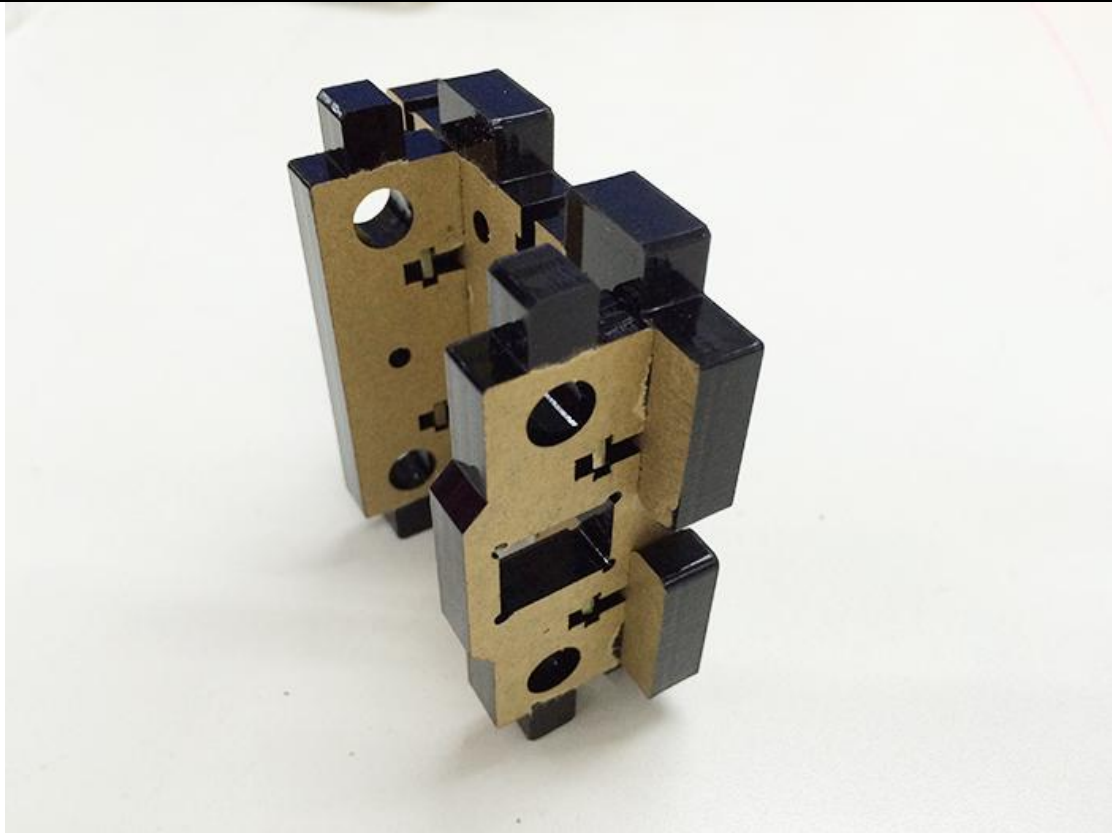



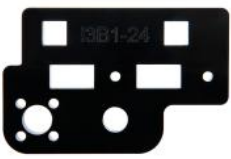

Step3. Mount the right bearing top and bottom plate.

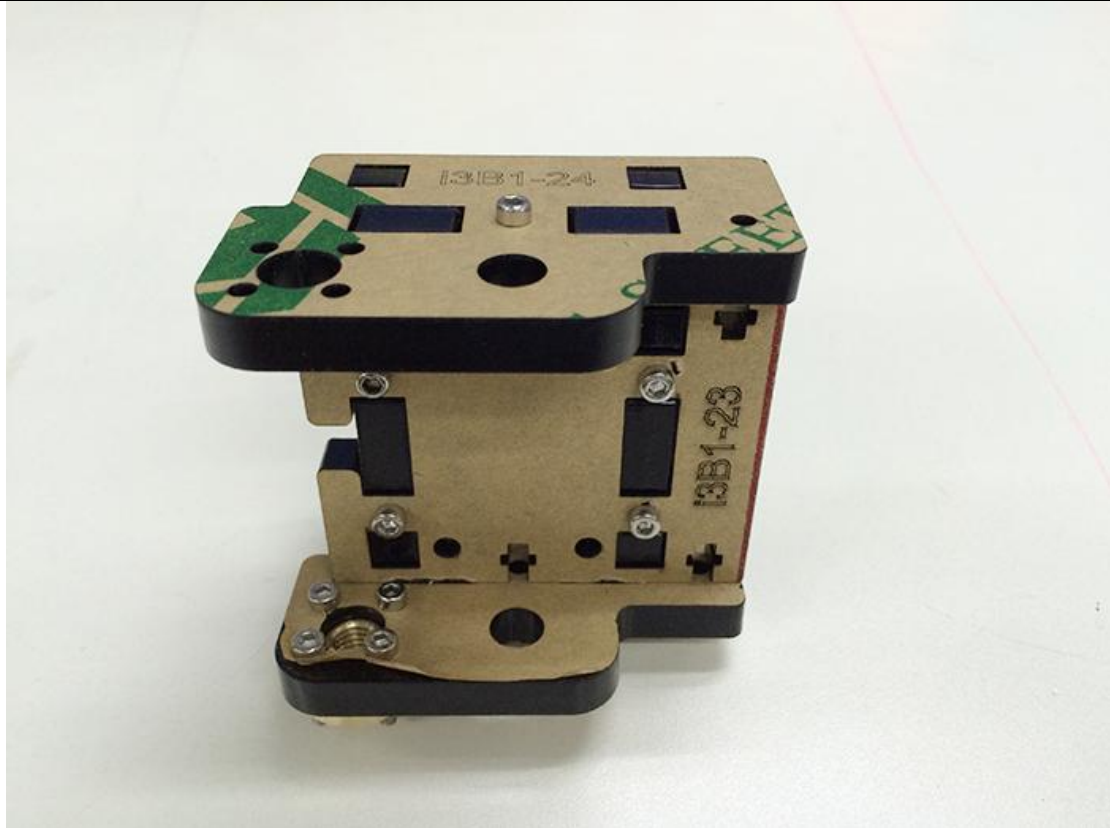
Part name	Part ID	Required number	pic
M3 x 16mm screw	No. 23	4	
M3 Square nut	No. 16	4	
Right bearing top/bottom plate	No.A24	1	

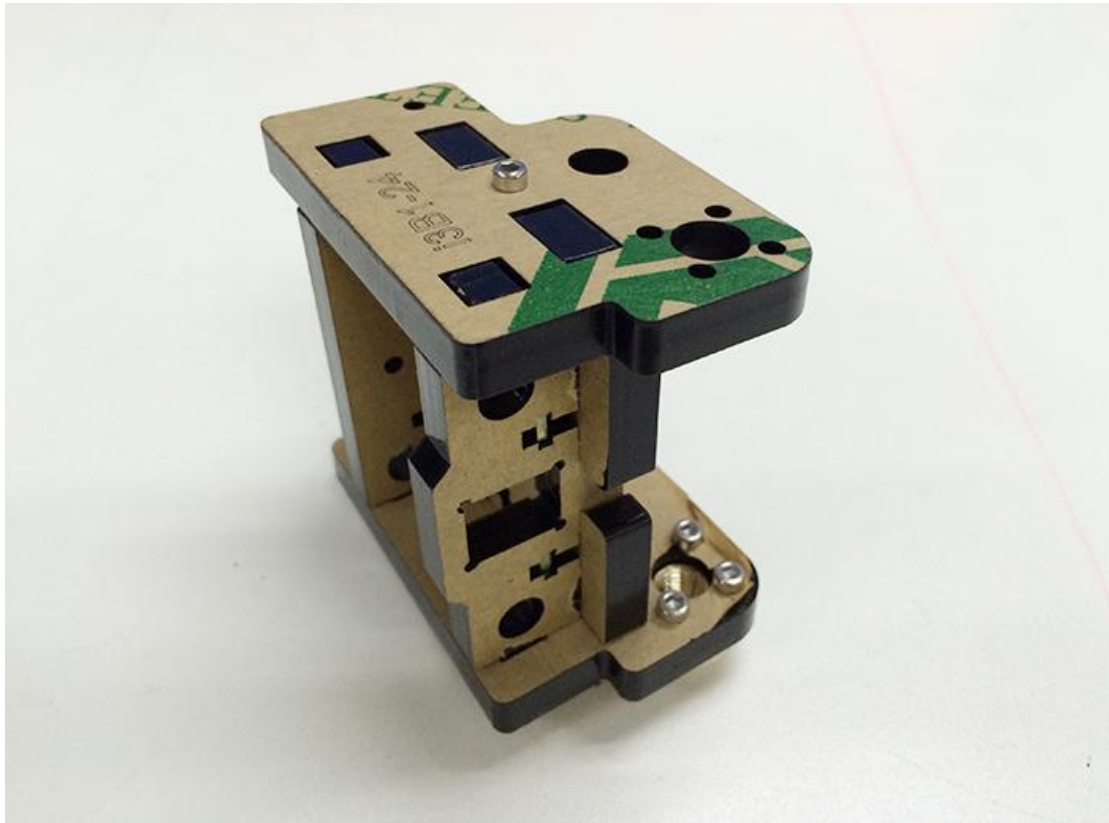



Step4. Fix the linear bearing PCS8LUU.

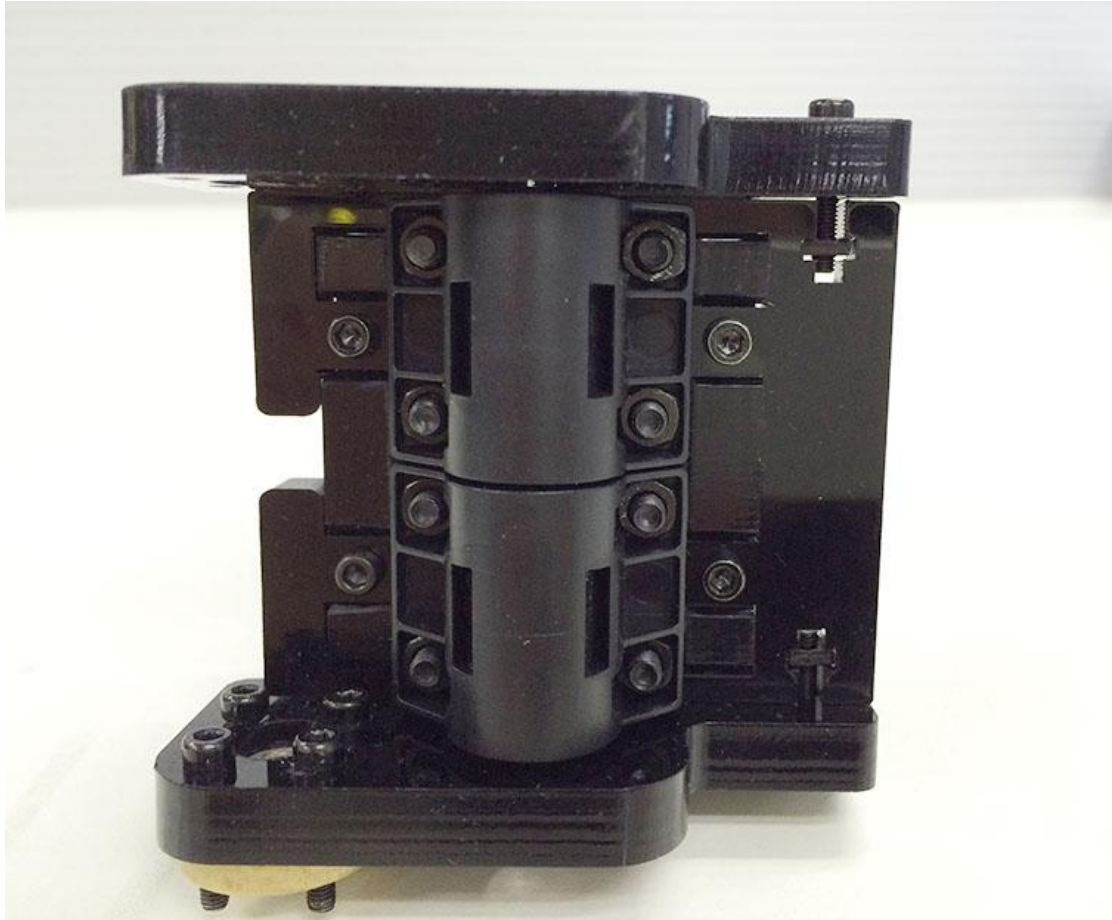

Part name	Part ID	Required number	pic
M4x16mm screw	No. 30	8	
linear bearing PCS8LUU	No. 32	2	
M4 hex nut	No. 12A	8	

Mount the PCS8LUU on Right bearing holder with M4x16mm screw and M4 hex nut.

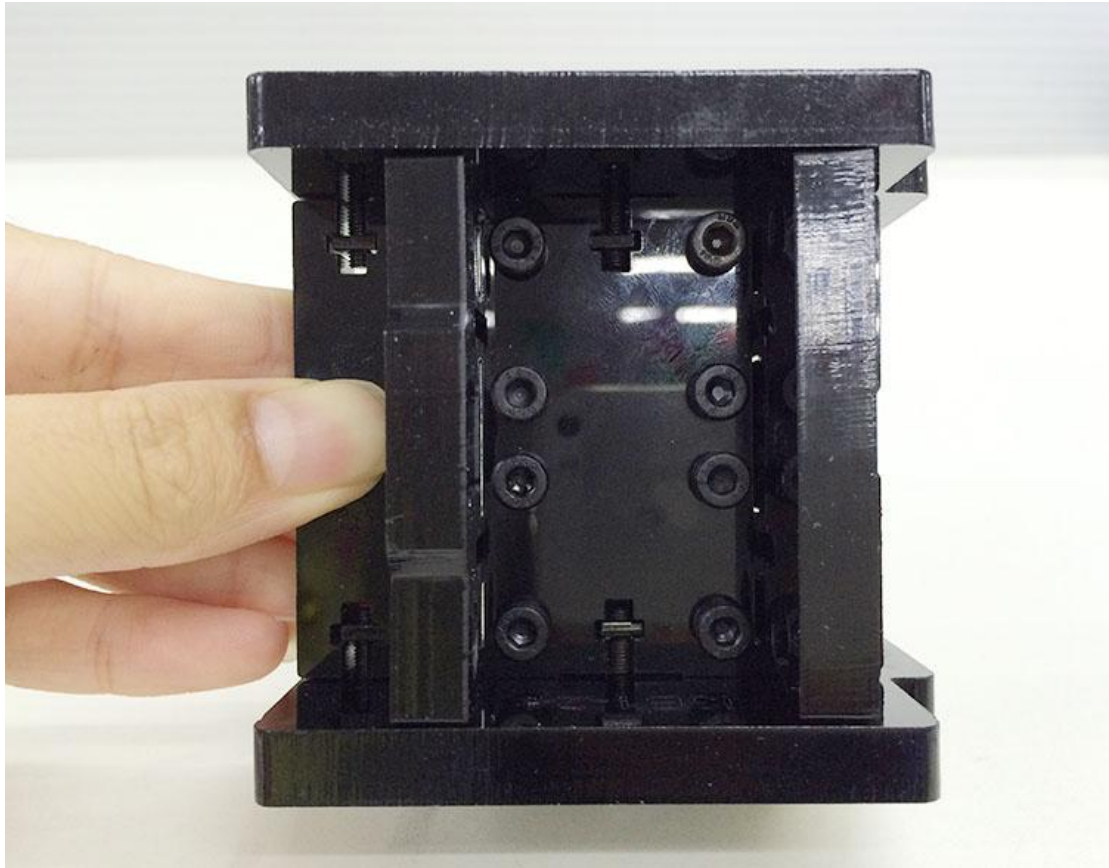

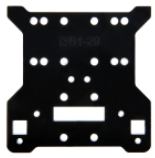

### 15. Assemble the extruder carriage

Part name	Part ID	Required number	pic
belt mount	No.41	1	
X axis bearing support plate	No.A 29	1	
Extruder Bracket	No.A30	1	

extruder bracket support	No.A31	2	
PCS8UU Linear Bearing	No.36	3	
M3 x 12mm screw	No.22	2	
M3 x 16mm screw	No.23	12	
M4x16mm screw	No. 30	12	
M3 Square nut	No.16	6	
M4 hex nut	No. 12A	12	

Step1. Mount the belt mount on the back of the X axis bearing support plate(No.A 29) with two M3x12mm screws .



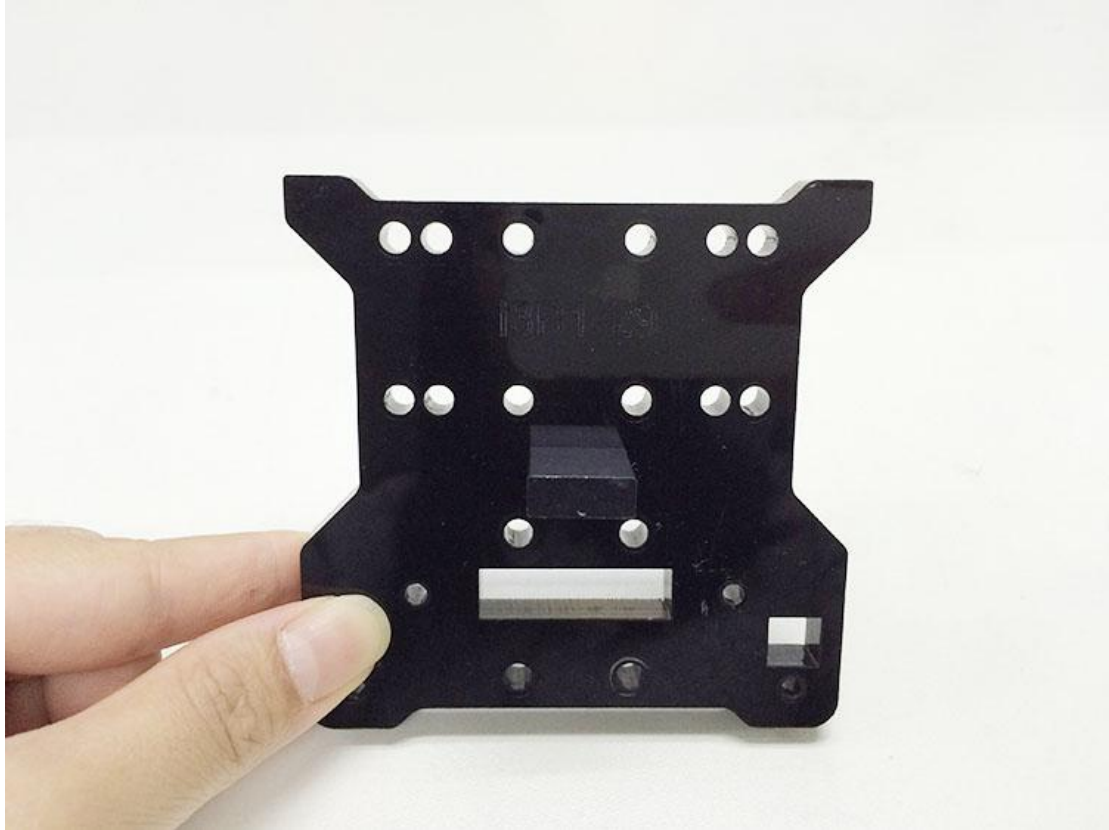

Step2. Mount the three PCS8UU Linear Bearing on the back of the X axis bearing support plate(No.A 29) with M4x16mm screws.

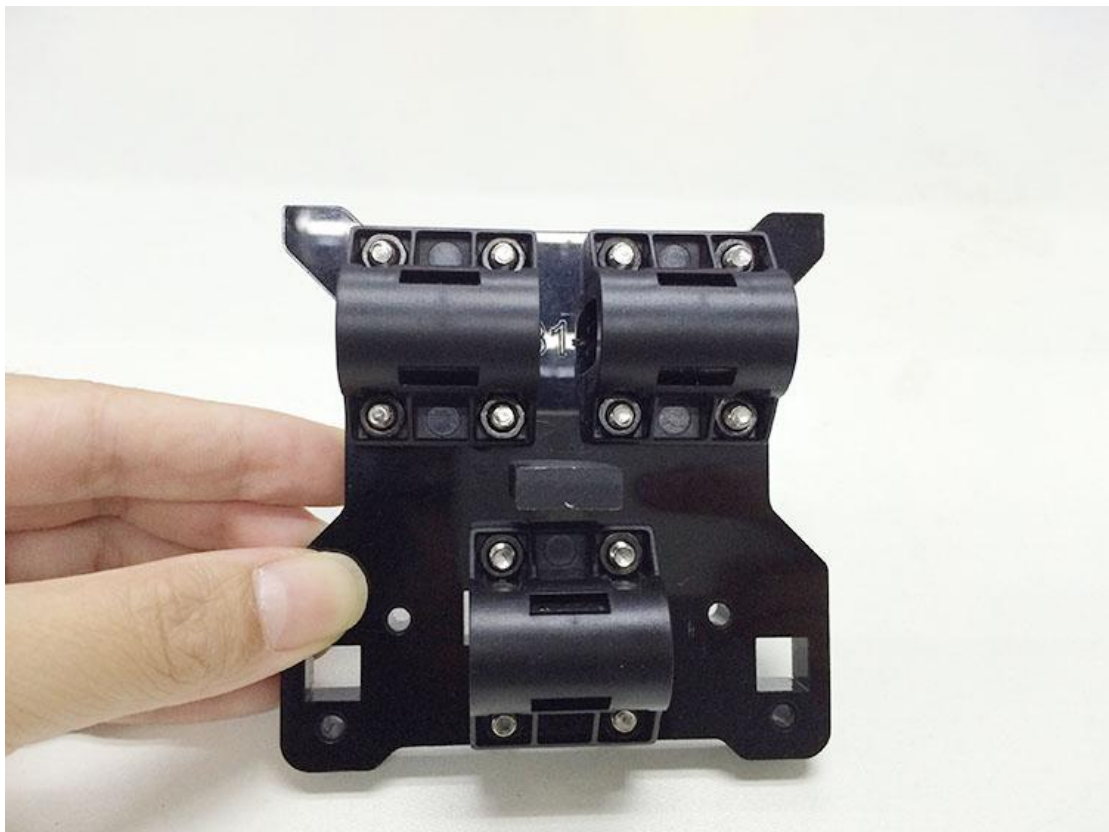

Step3. Mount the 2 No.A31 under the Extruder Bracket(No.A30) with 2 M3 x 16mm screw and M3 Square nut.

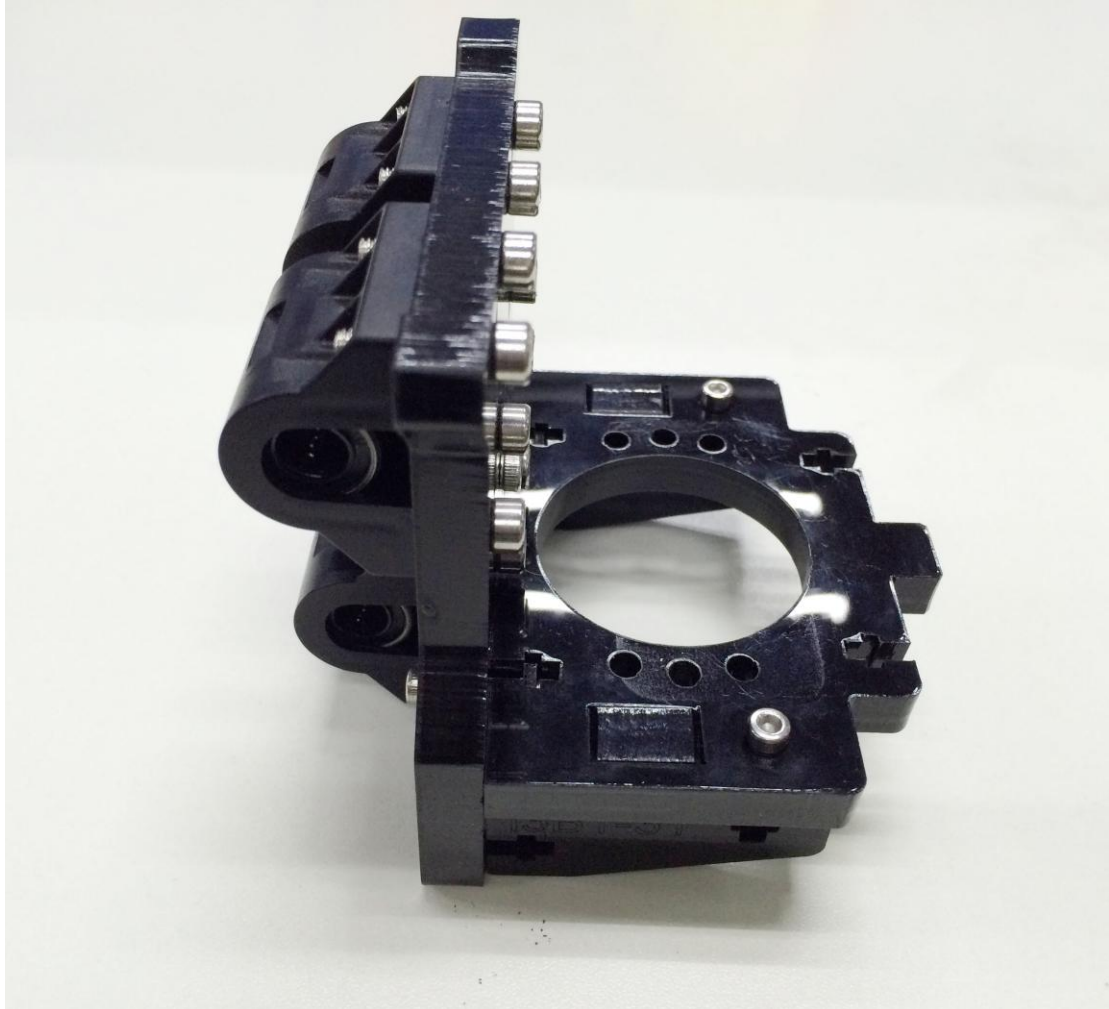



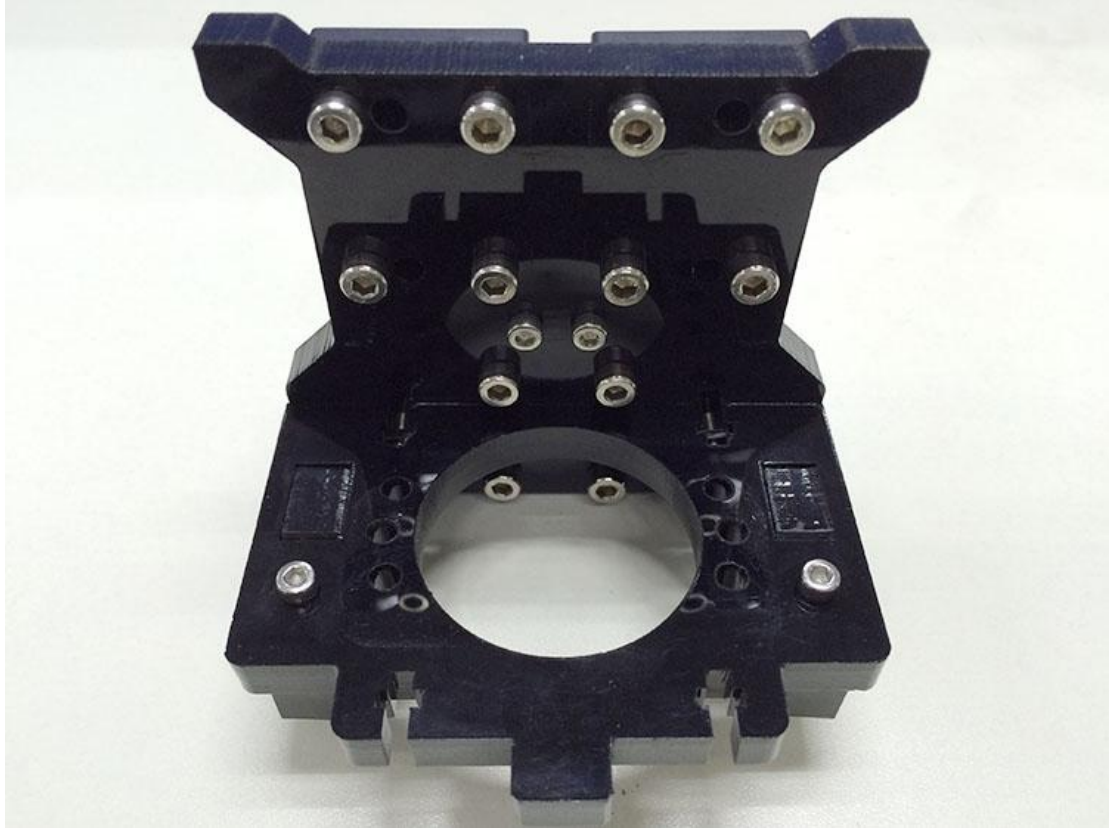

Step4. Connect the No.A30 to No.A 29 with 2 M3 x 16mm screw and M3 Square nut.





For detailed assembly process, please watch [here](#).

(Linear Bearings in the video is different from this manual, but it will not affect your assembly, you can still finish it)

### 16. Assemble the the X&Z axis

Part name	Part ID	Required number	pic
L430mm smooth rod	No.2	2	
X axis Fender	No.A27	2	
locking ring	No.32	4	
L322mm smooth rod	No.1	2	
L300mm threaded rod	No.4	2	

Z top mount	No.A8	2	
M3 x 16mm screw	No.23	6	
M3 Square nut	No.16	6	

Step 1. Thread the to L300 mm THREADED rods into the left and right end separately.

**Note:** please make sure the holes are aliened, if not, you can loose the SCS8UU Linear Bearing a bit, then you can thread smoothly.



Step 2. Take the X motor end, thread the 2 L430mm smooth rod into the hole> thread the extruder carriage on the smooth rod> thread 1locking ring on each rod> thread 1

X axis Fender on each rod> thread the X idler end to the end of the rod.

Step 3. Put the threaded rod into the coupling on both Z motor. You need to adjust the place of the X motor and idler end on both end of X axis smooth rod so that the threaded rod can fit into the couplings.

**\* Adjust the two end of the X axis to make sure the smooth rods and the threaded rod of Z axis is vertical, and the two end of the X axis are horizontal , which is very important, or it will hinder the move of the Z axis.**



Step 4. Upon adjusting, thread the two L322mm smooth rod into both X motor end and idler end. If the rod cannot smoothly get through the linear bearing, you can loose the M4x16mm screws of the bearing.

Step 5. Thread the 1 locking ring to each L322mm smooth rod of the Z axis .

Step 6. Add the Z top mount to the Z axis. Screw it up with M3 x 16mm screw and M3 Square nut.

Watch the video [here](#).

### 17. Assemble the X motor

Part name	Part ID	Required number	pic
stepper motor	No.63	3	
M3 x12mm screw	No.22	12	
Pulley	No.42	1	

Step1. Mount the pulley on the motor shaft, one of the screws should be screwed on

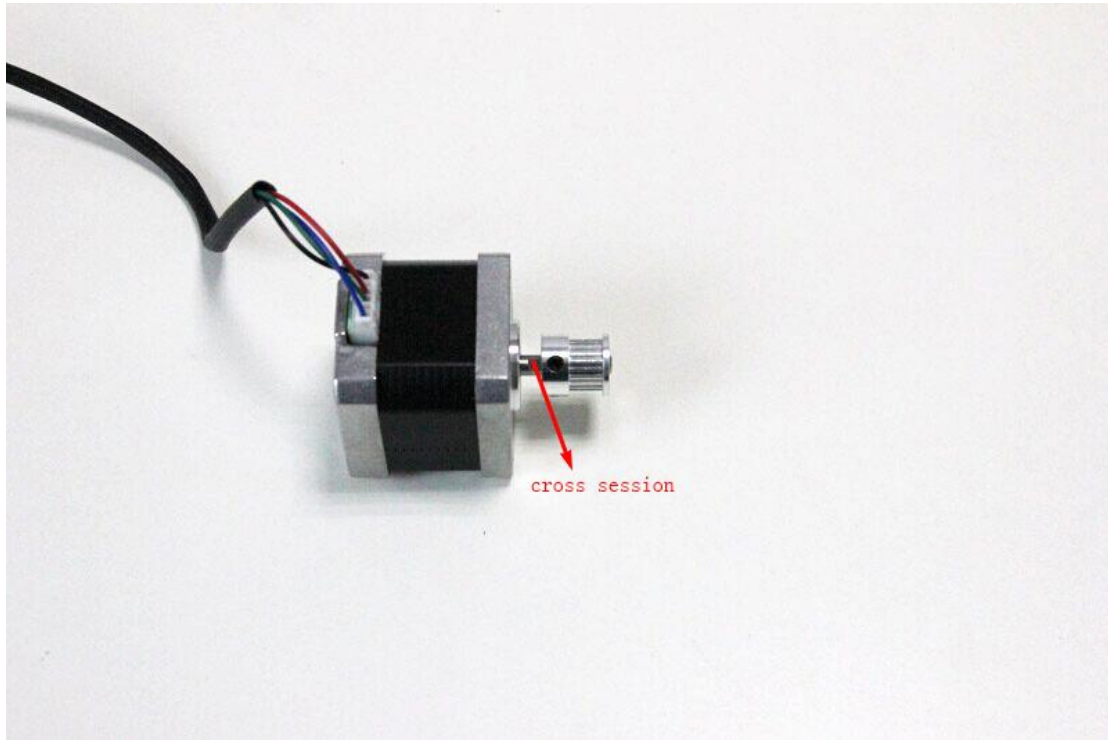

the cross section of the shaft. **Screw it tightly.** (screw set is in the hole of the pulley)



Step2. Then screw the motor on A16 plate with 4 M3 x 12 screws .

Watch the [video](#).

### 18. Add the belt

Part name	Part ID	Required number	pic
Timing belt	No.39	1	
M3 x8mm screw	No.21	1	
M3 washer	No.7	1	

Step1. Punch a M2.5 hole on one end of the belt (the hole can be as the diameter of the M2.5 screw to drill instead, leave enough margin )

Step2. Fix the belt on one side of the belt -mount with a M3 x 8 screw and washer.

Step3. Thread the belt around the pulley on the motor and the driving wheel (with M3x40mm screw we assembled just before).

Step4. Taut the belt and mark the place to punch the second hole and punch a M2.5 hole if you are sure of the belt length.

Step5. Mount the belt on another side of the belt mount with a M3 x 8 screw and washer.

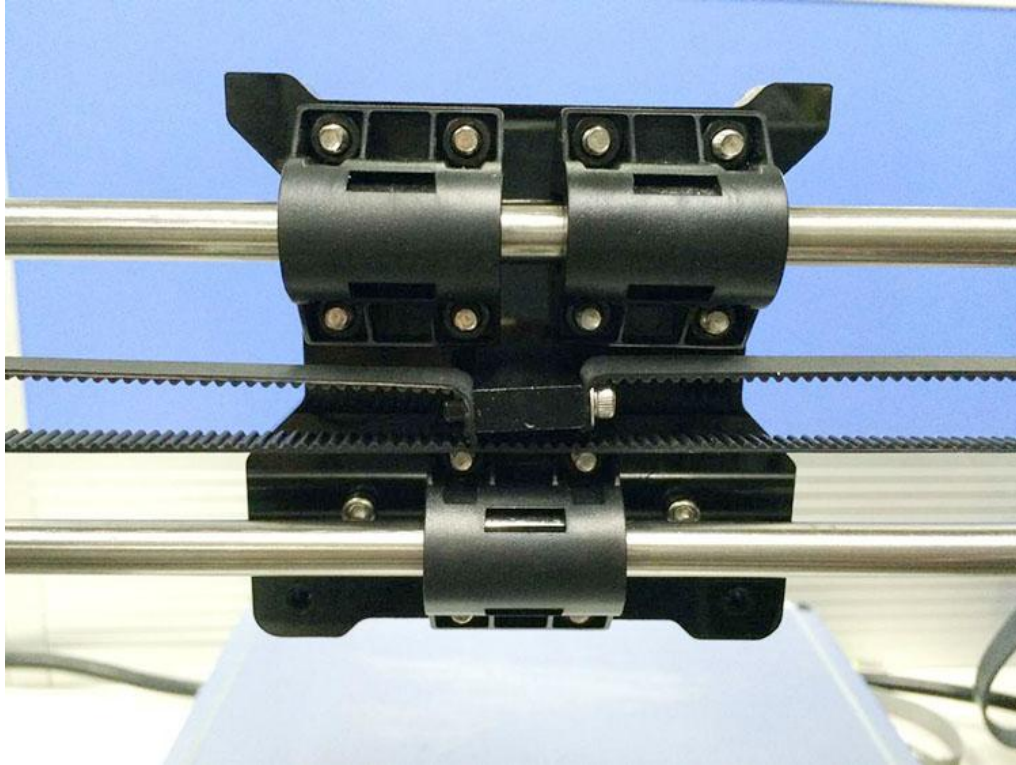

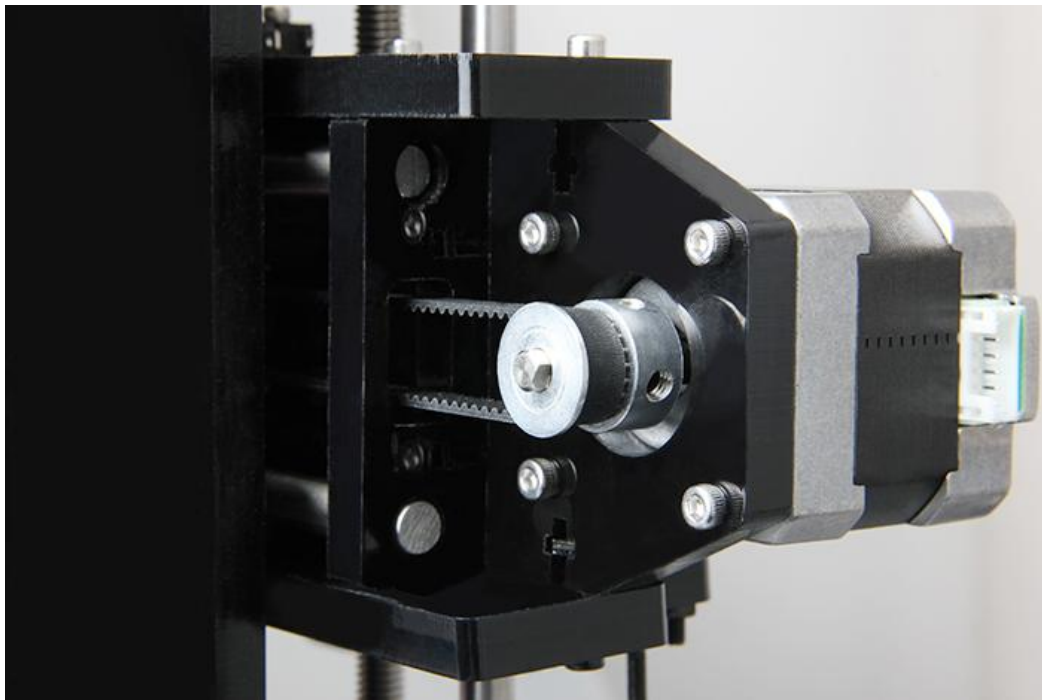
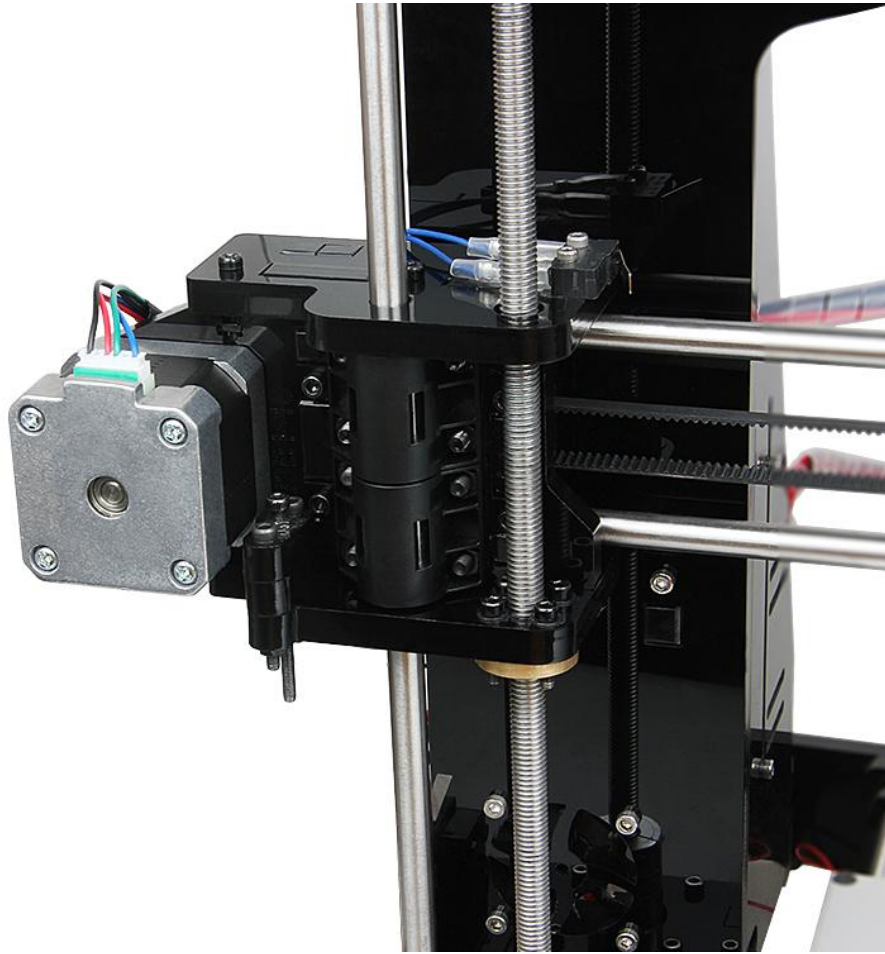



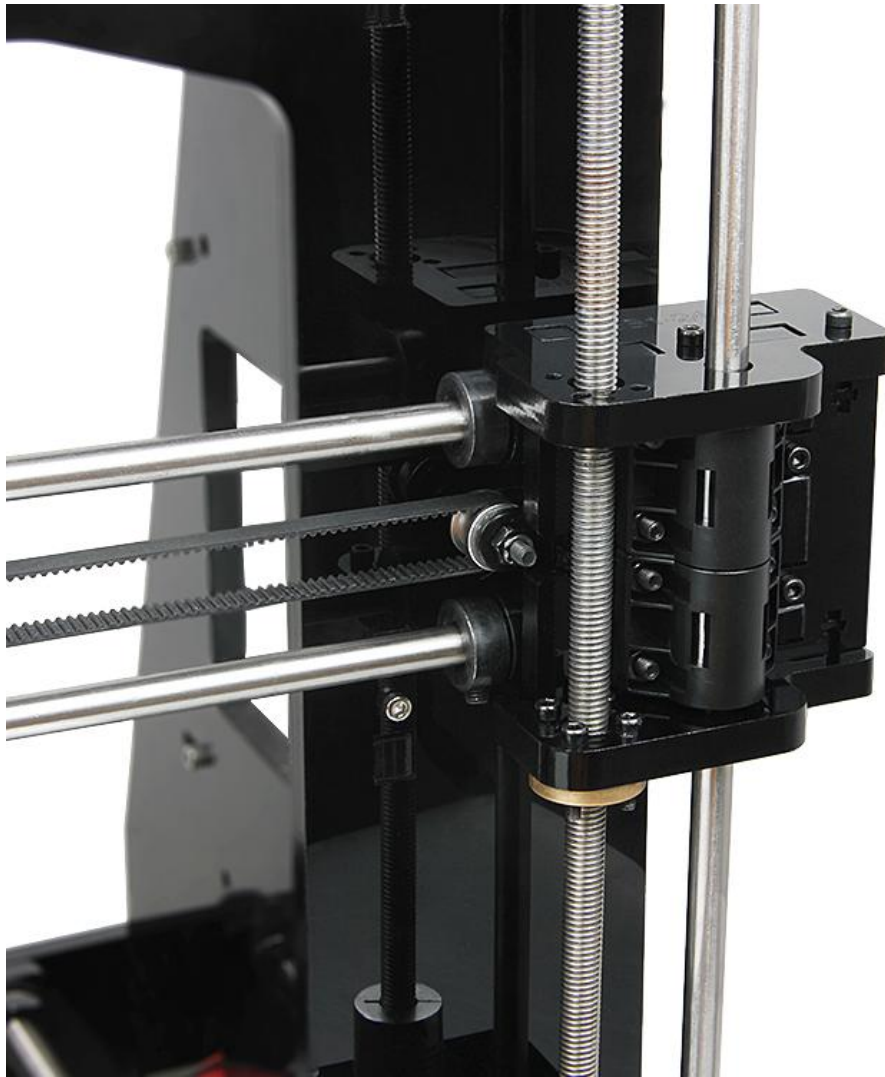



Watch the [video](#).

(Linear Bearings in the video is different from this manual, but it will not affect your assembly, you can still finish it)

### 19. Mount the extruder.

Part name	Part ID	Required number	pic
Extruder	No. 61	1	

M4x12mm Screw	No.29	2	
---------------	-------	---	---

Step 1.Thread the extruder into the extruder carriage.

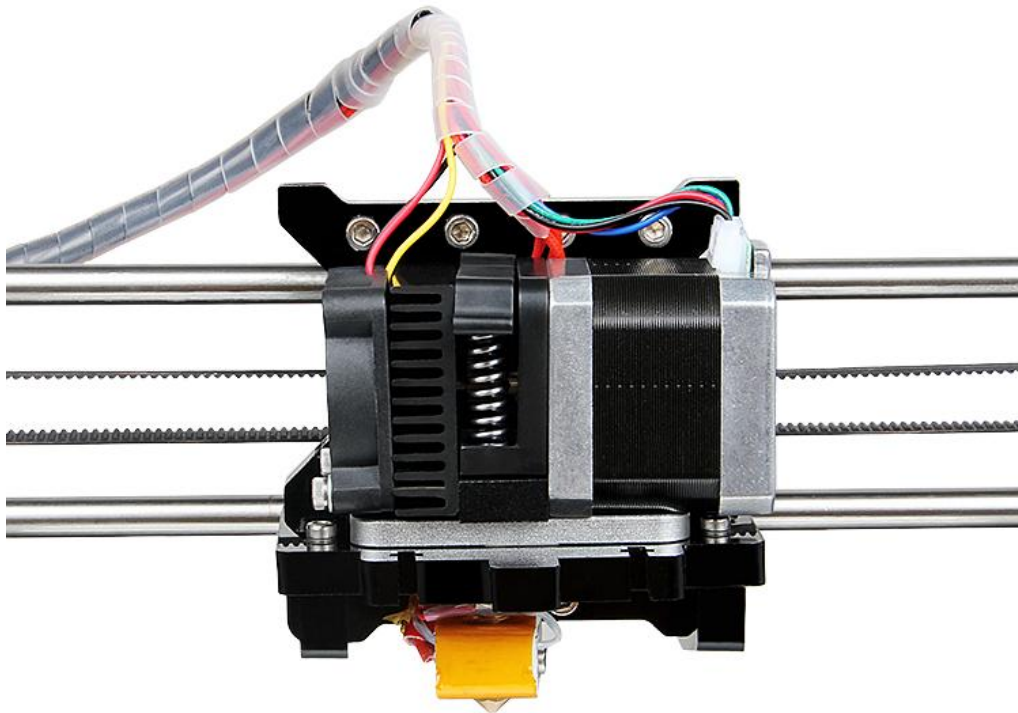

Step 2. Fix the extruder with 2 M4x12mm screws.

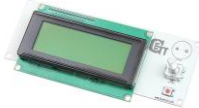

Watch the [video](#).

## 20. Mount the LCD panel

Part name	Part ID	Required number	pic
LCD 2004	No.64	1	

Knob	No.65	1	
Spacer	No.50	4	
M3 x 12mm screw	No.22	4	

Step 1. Insert the spacer into the 4 holes on the LCD panel from front to back.

Step 2. Mount the LCD on the main frame (A1) with 4 M3 x 12mm screws.

Step 3. Screw up the knob.( The screw is inside)



Pay attention to the two connectors at the back of the LCD.



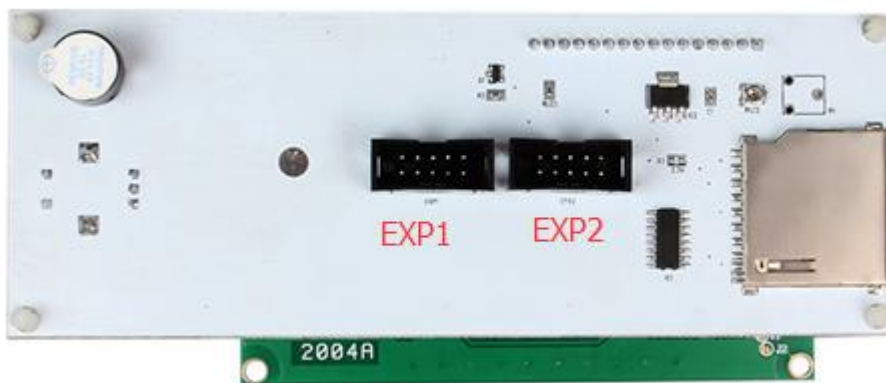

EXP 1 is for the LCD. EXP 2 is for the displaying of the SD card reader.

Do not mix them up.



Watch the [video](#).

**21. Mount the control board.**

Part name	Part ID	Required number	pic
Control board kit	No.62	1	
Sticker	No.47	1	
Heat sink	No.48	1	
Spacer	No.50	4	
M3 x 12mm screw	No.22	4	

Step 1. Cut the sticker into small pieces.

Step2. Past the heat sink onto the chip of the A4988 drivers. The sticker is double sided adhesive.



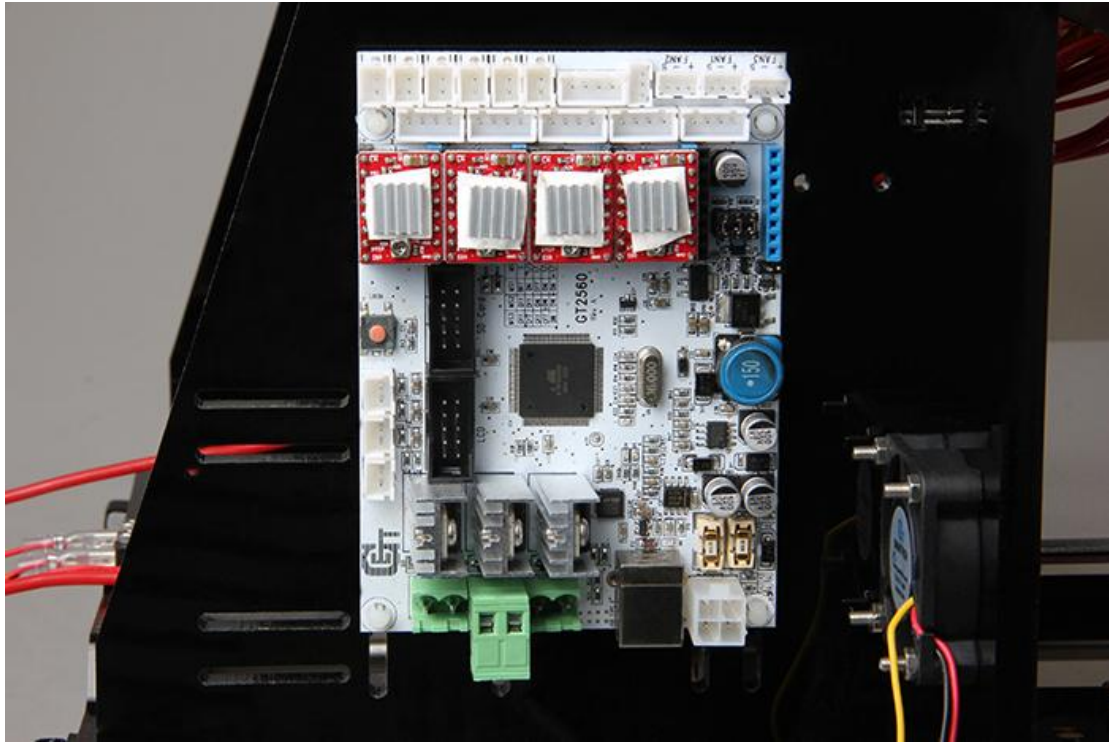

Step 3. Insert the spacer into the 4 holes of the board from back to front.

Step 4. Mount the board on the left side panel with 4 M3 x 12mm screws.

Watch the [video](#)



## 22. Mount the building platform.

Part name	Part ID	Required number	pic
Building platform	No.44	1	
Heatbed set	No.53,54,55	1set	
wing nut	No.15	4	
Hex Counter-sunk-head screw	No.19	4	
Spring	No.33	4	

Step 1.Stack the heatbed and the aluminum plate together.

Step 2.connect the heatbed and the aluminum plate to the acrylic plate(A15) with 4 Hex Counter-sunk-head screw with the spring in between.

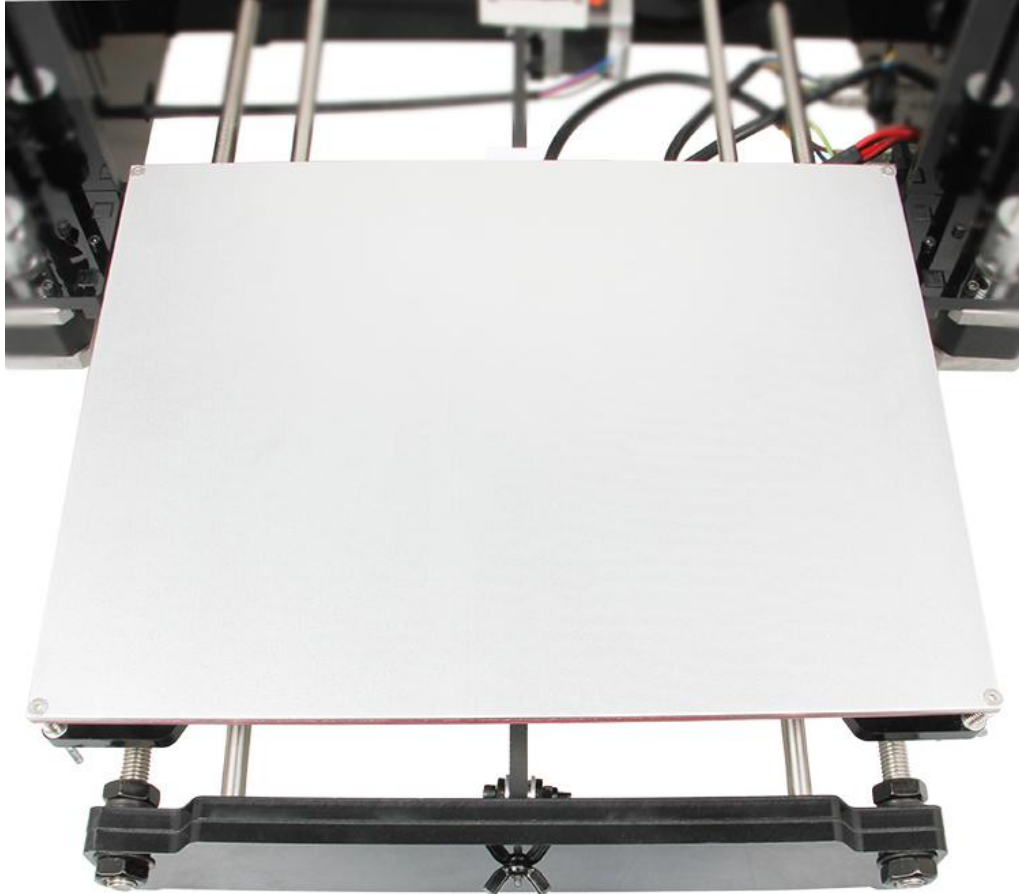

Step 3. Lock the screw with a wing nut.



Watch the [video](#)

### 23. Mount the Y endstop

Part name	Part ID	Required number	pic
end stop	No.52	1	



M2.5 hex nut	No.11	2	
M2.5x16mm screw	No.20	2	

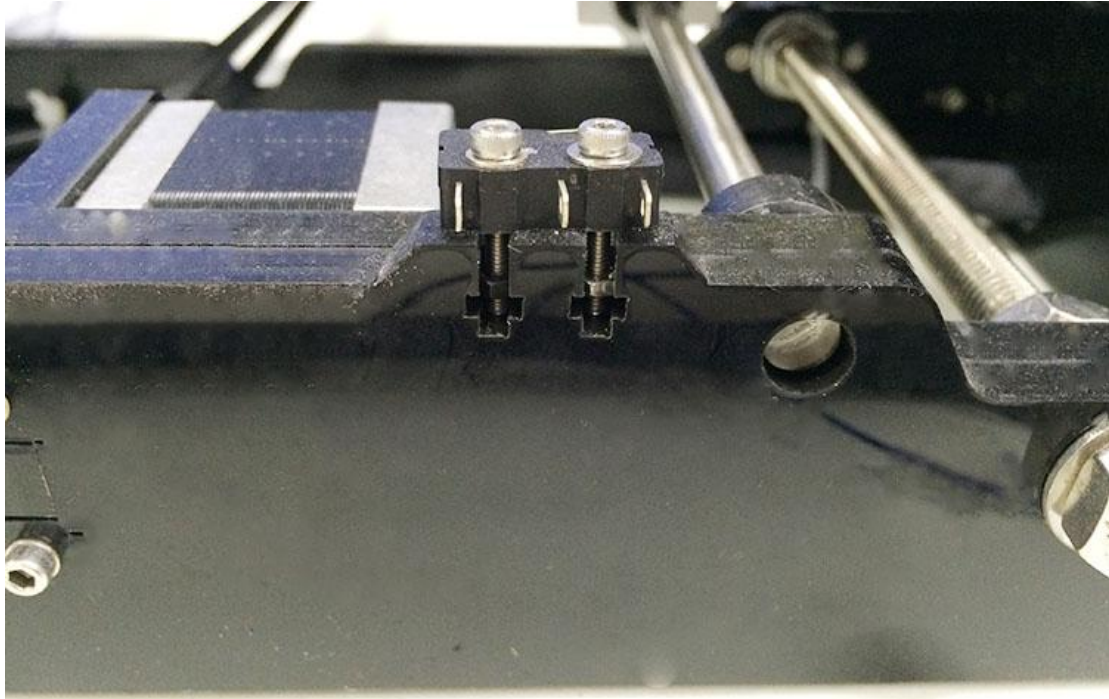

Mount the endstop onto the rear plate with 2 M2.5x16mm screws and M2.5 hex nuts.



Watch the [video](#).

**24.Mount the power supply unit (PSU ) and the socket.**

Part name	Part ID	Required number	pic
Power supply Unit	No.58	1	
3D Power Cable	No.60	1	
Power Cable	No.59	1	

M3 x 12mm screw	No.22	4	
Hex Counter-sunk-head screw	No.18	2	
M3 hex nut	No. 12	2	

Watch the [video](#).

Step1. take off the wires connected to the socket, before you do, please take a photo of the wire connection, in case you connect them wrongly later.





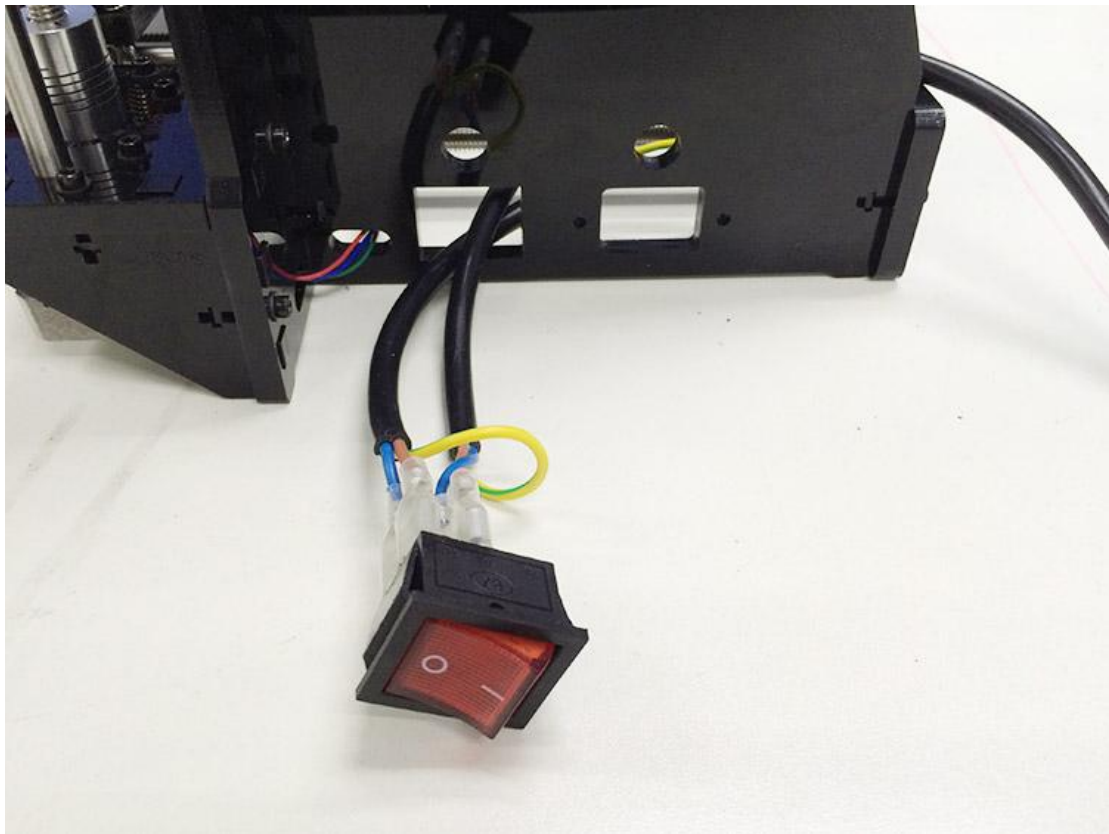
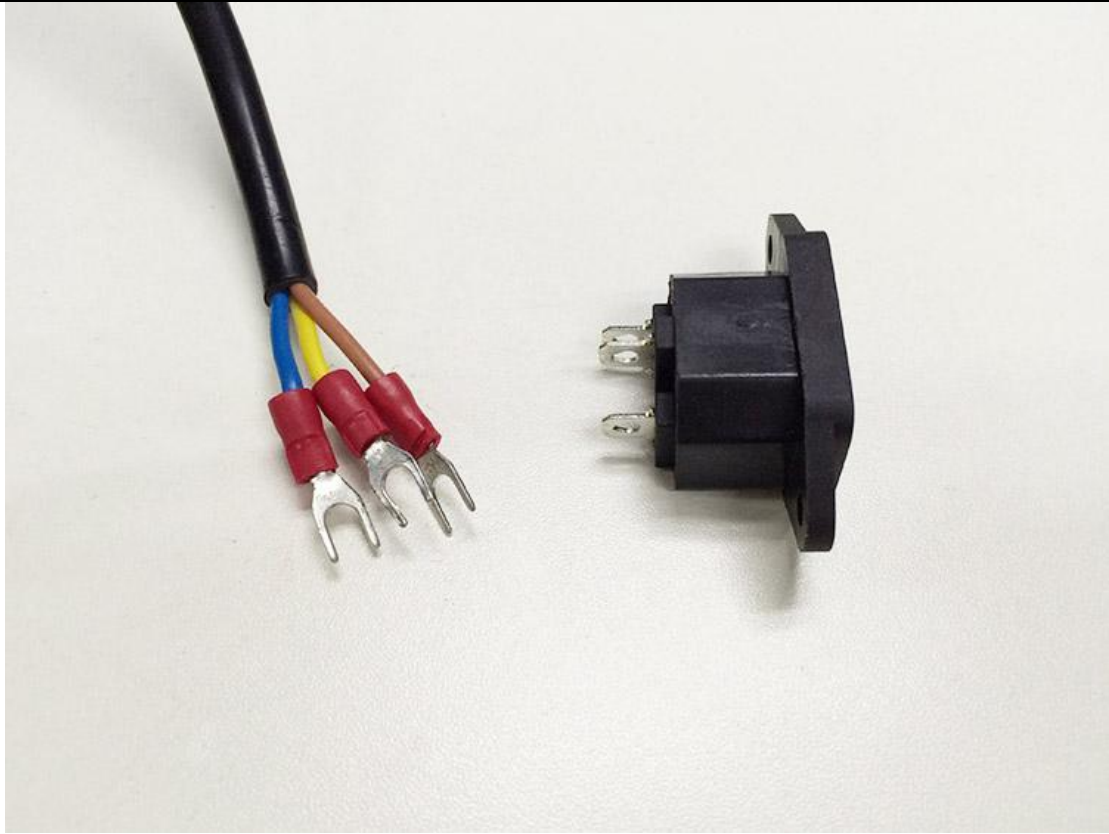

Step2. Mount the socket on the bottom of the right side panel( A2) with 2 M3 x 16 Hex Counter- sunk-head screws and M3 hex nut.

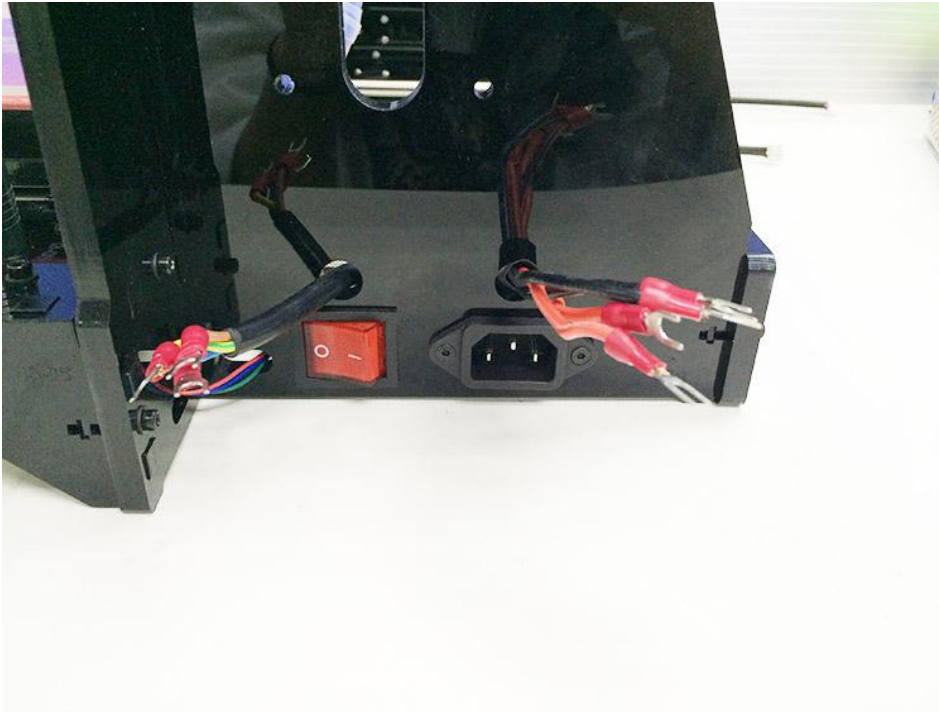





Step3. Thread the wires connected to the switch through another hole on the bottom of the right side panel( A2) from outside to inside and connect the 3 wires to the socket, do not mix them up.

Step4. Mount the PSU on the right side panel with 4 M3 x 12mm screws.

Step5. Connect the wires. Do not forget to cover the connectors.

\* Note the colors and their corresponding connection as a mistake can cause you harm or damage the printer. If you are unsure of your skills and abilities here, please consult a professional.

---

BROWN		Live (L)
BLUE		Neutral (N)
GREEN / YELLOW		Ground (GND)
RED		Positive (V+)
BLACK		Common (COM)



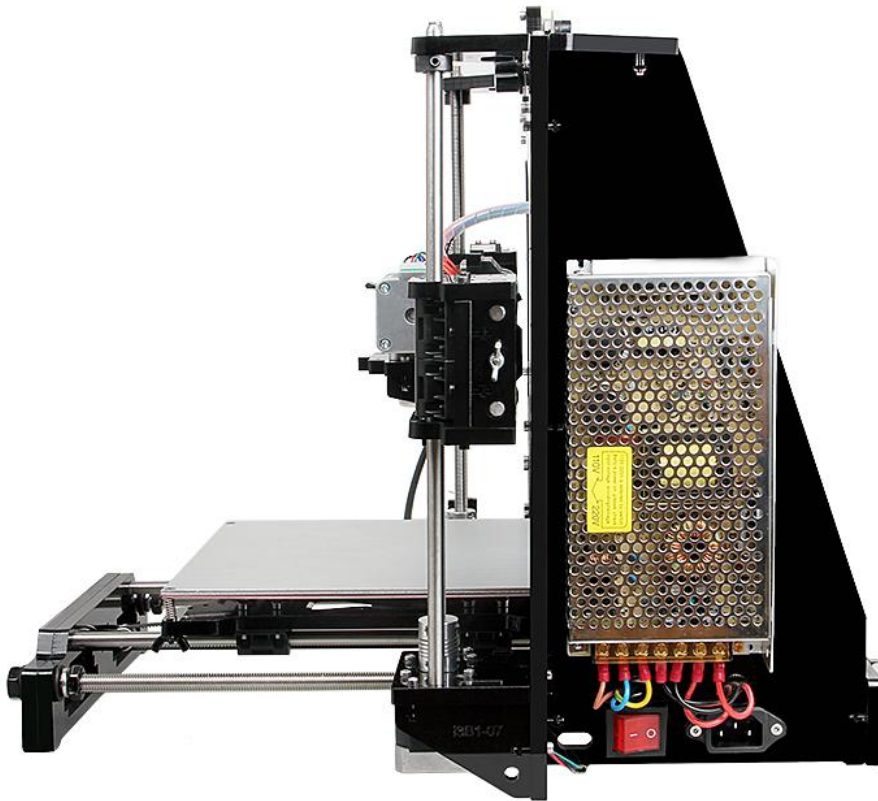

## 25 Wiring

Before you start wiring, please take a look at the wiring schematics.

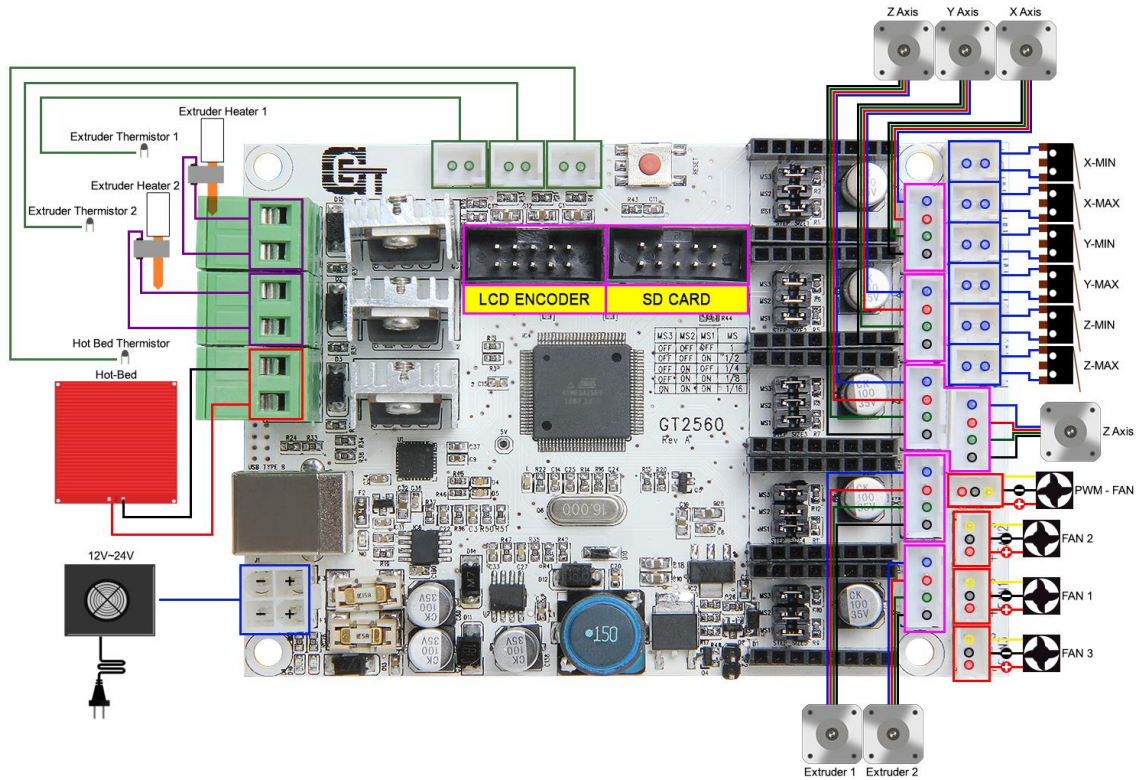

You can see original picture [here](#).

For your convenience, the first two steps have been finished by us before shipping.  
you can skip them.

### **Step1. Check the subdivision of stepper motor**

The subdivision of stepper motor can be setup by jumper cap, plug all the jumper caps  
(For A4988)

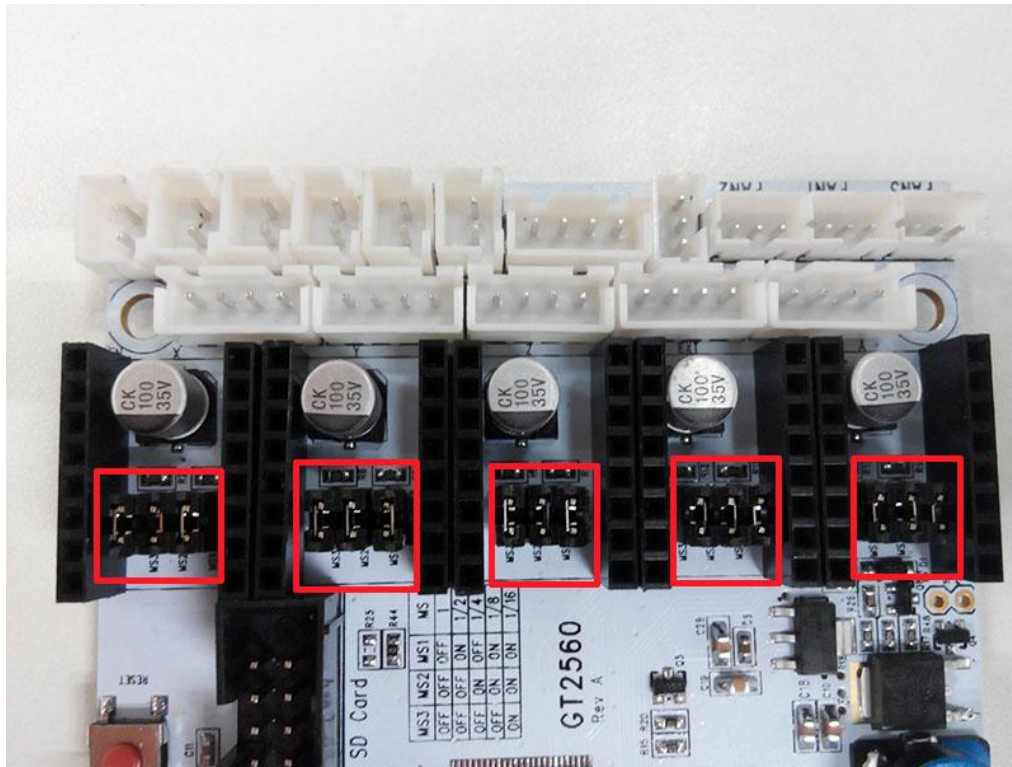

If you are using DRV8825 instead of A4988, the jumper caps should be changed as follow:

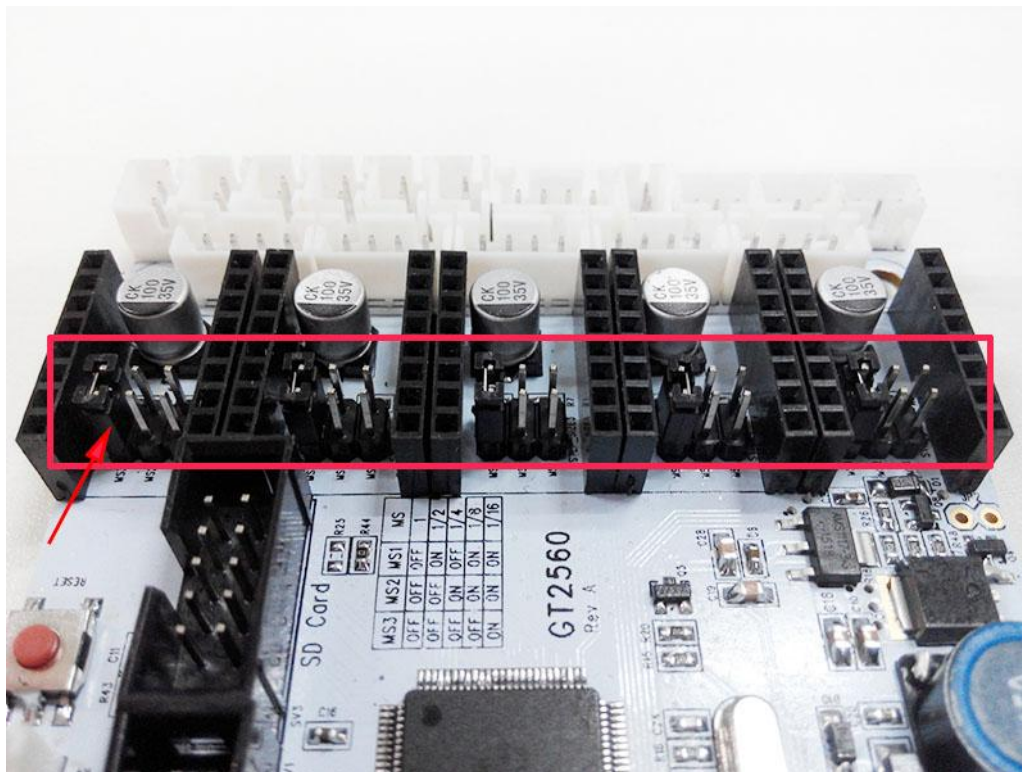

**Step2. Plug stepper motor driver**

Plug the 5 A4988 into the stepper motor driver slot. Mind the directions of A4988.

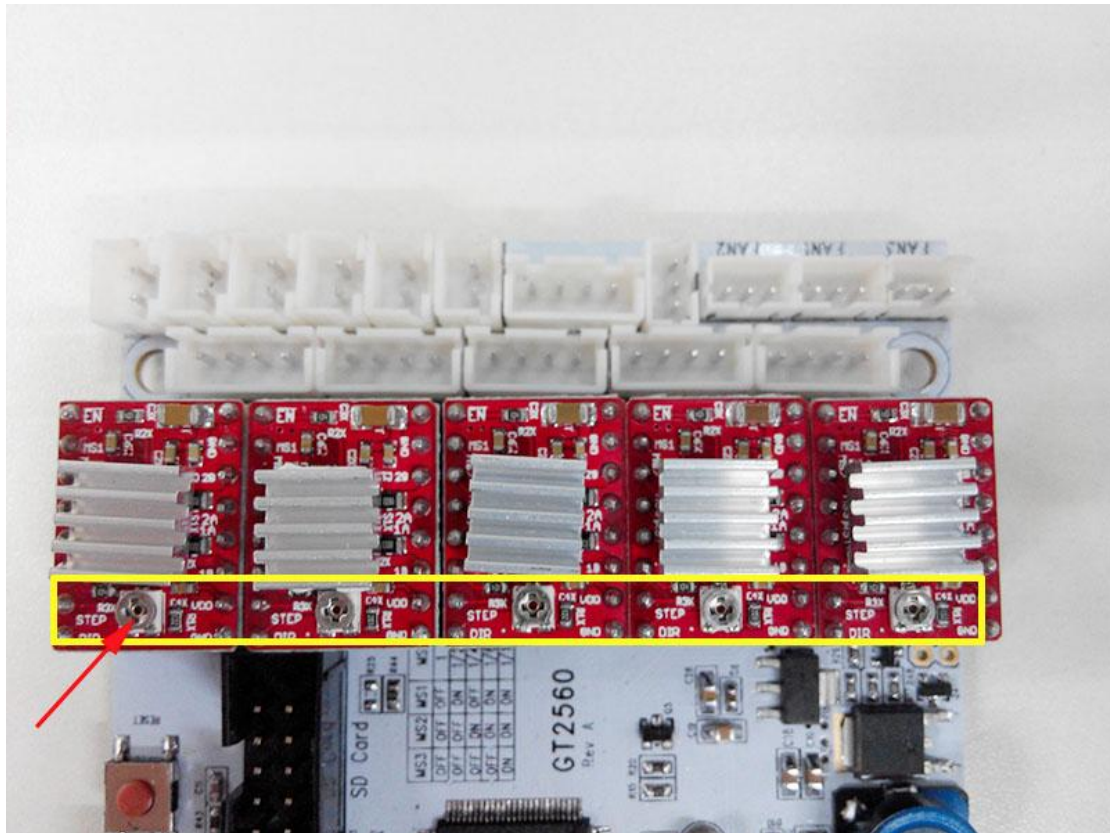

If you are using DRV8825 instead of A4988, The correct connections are as follow:

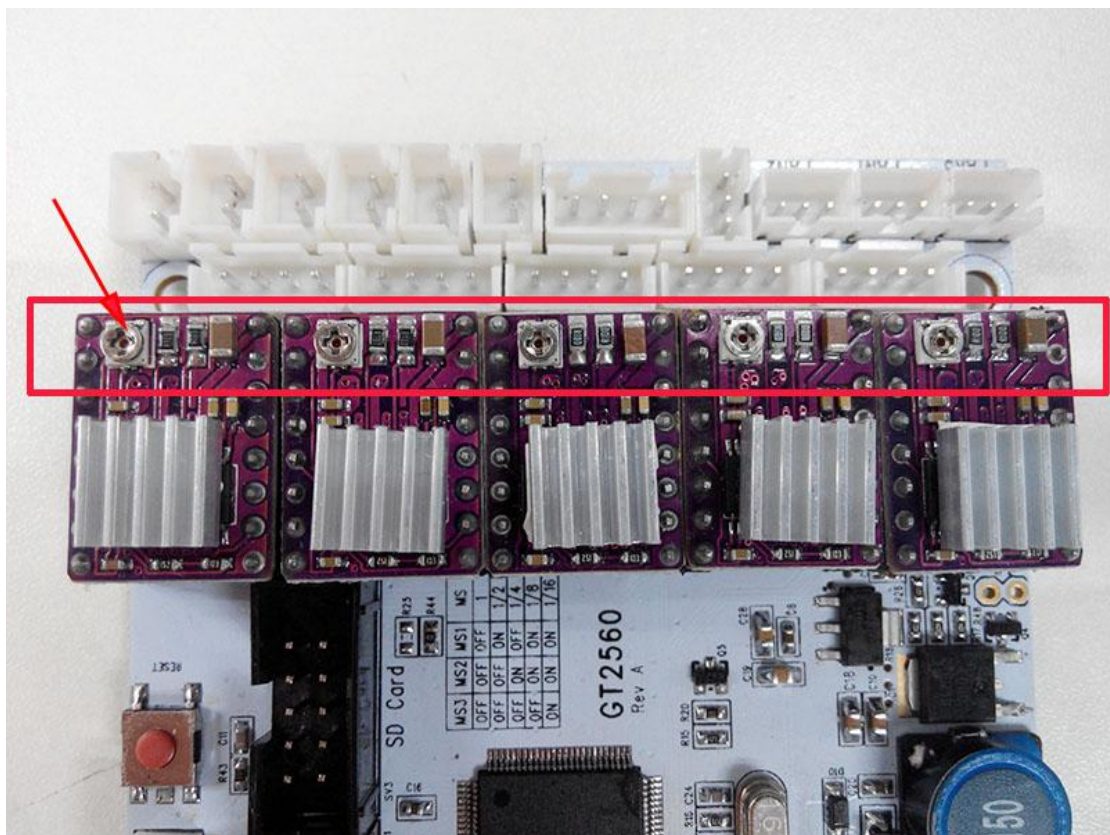

Step3. Connect wires for motors. 1) Connect wires for X-axis motor.

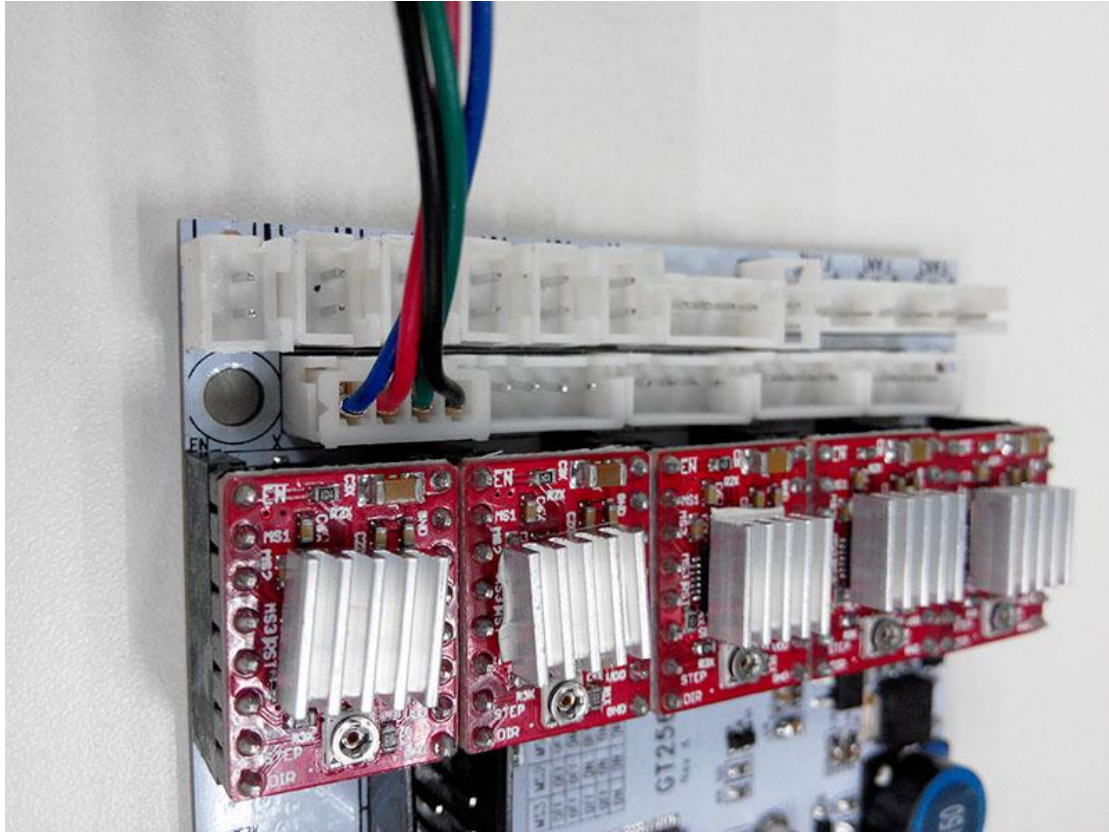

2) Connect wires for Y-axis motor.

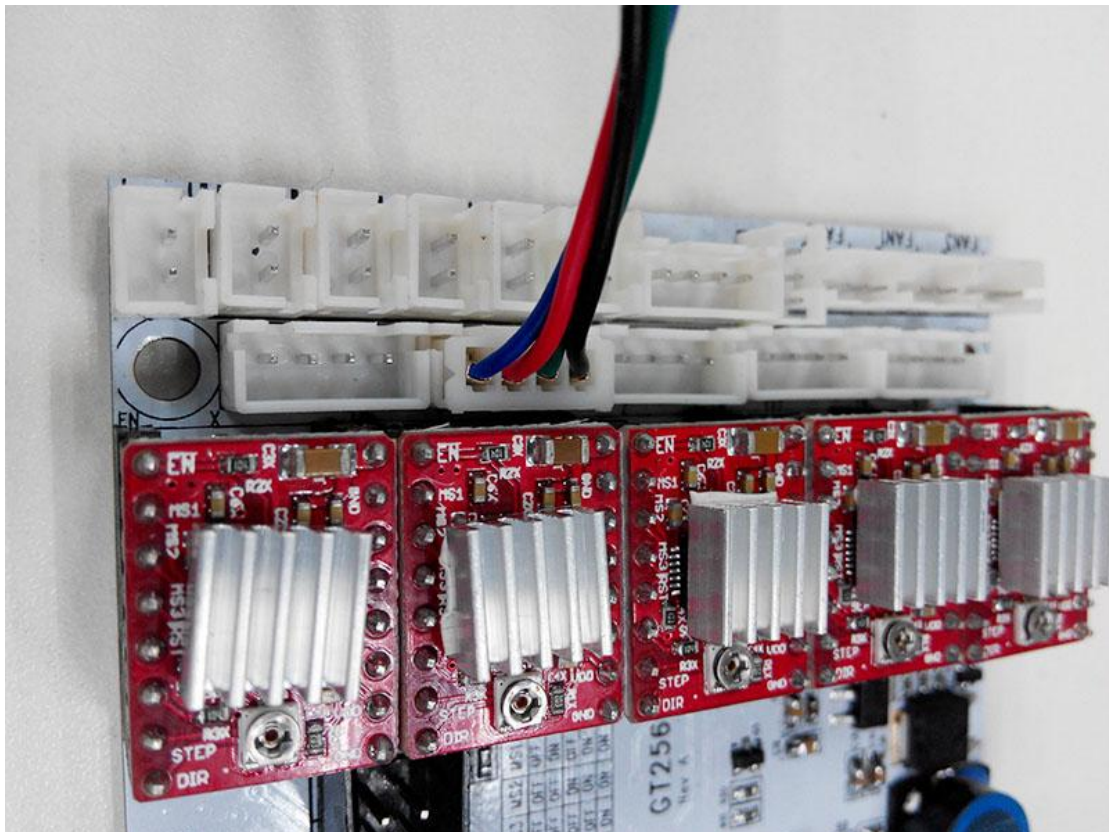



3) Connect wires for the 2 Z-axis motors.

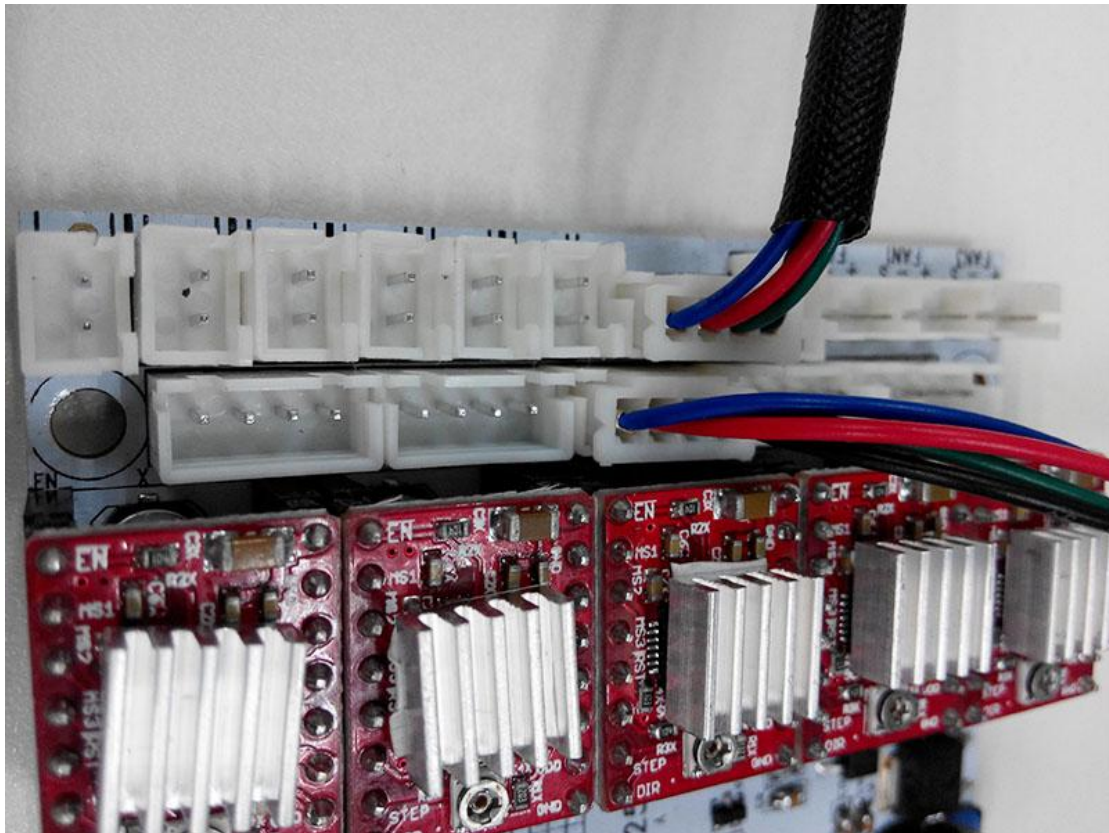

4) Connect Extruder motors. Connect extruder 1.

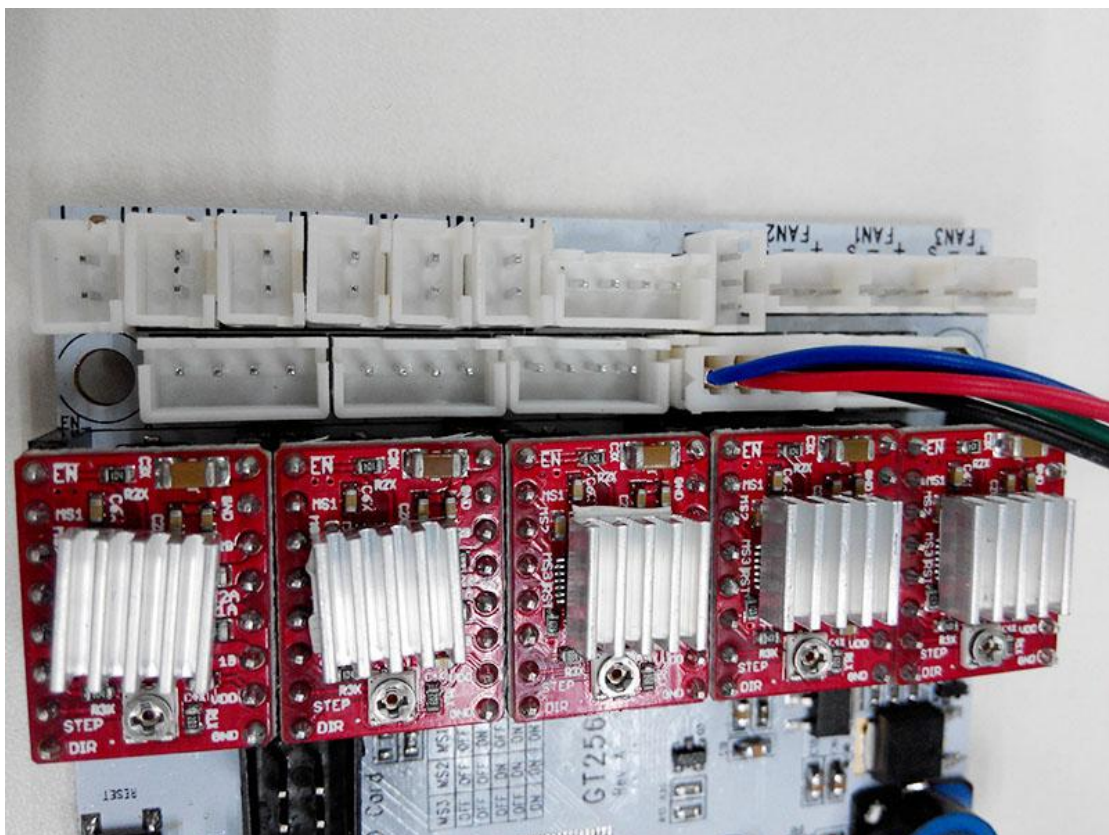

Connect extruder 2, if you are assembling the Prusa X-2 dual extruder model.

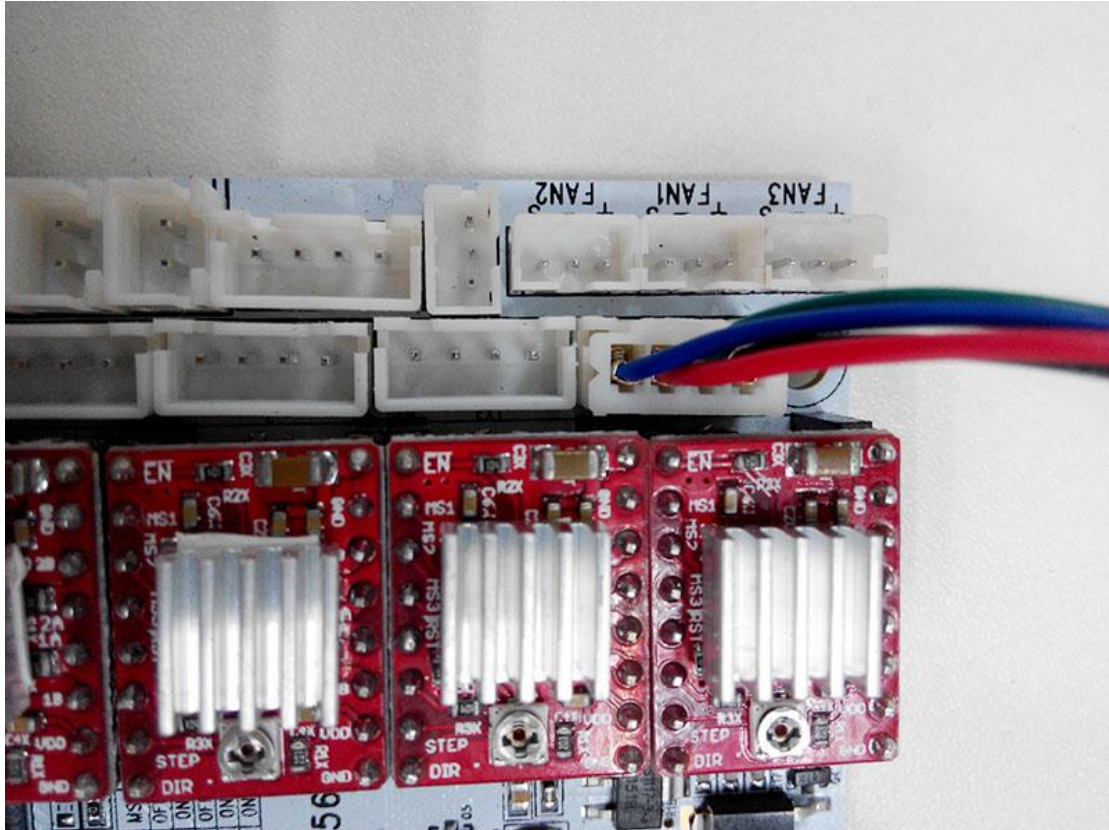

#### Step4. Connect heating wires.

Loosed the screws in the green terminal and put the red wires into the slot and screw it up. \* There is no “+” and “-“ polarity for heating wires

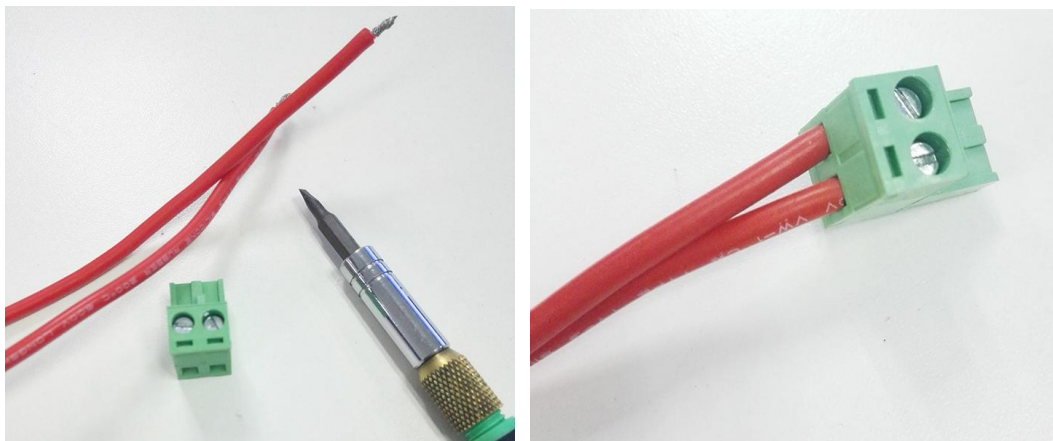

1) Connect heating wires for heatbed.

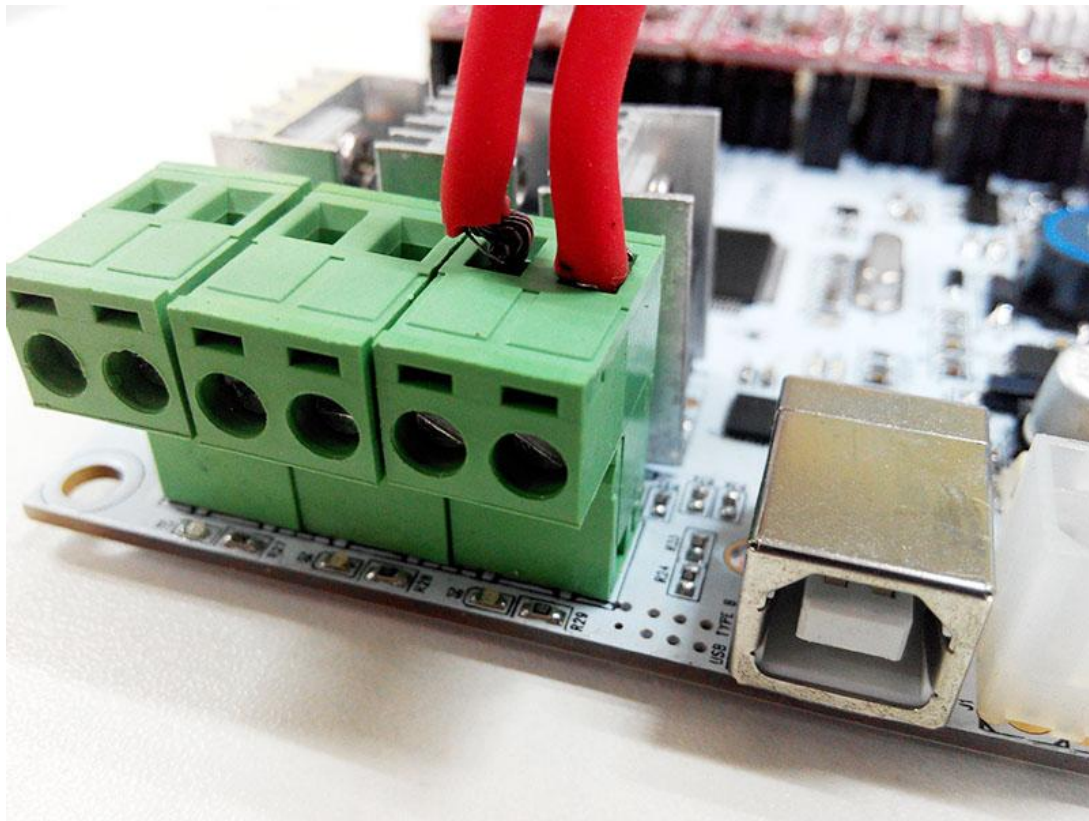

2) Connect heating wires for extruder 1.

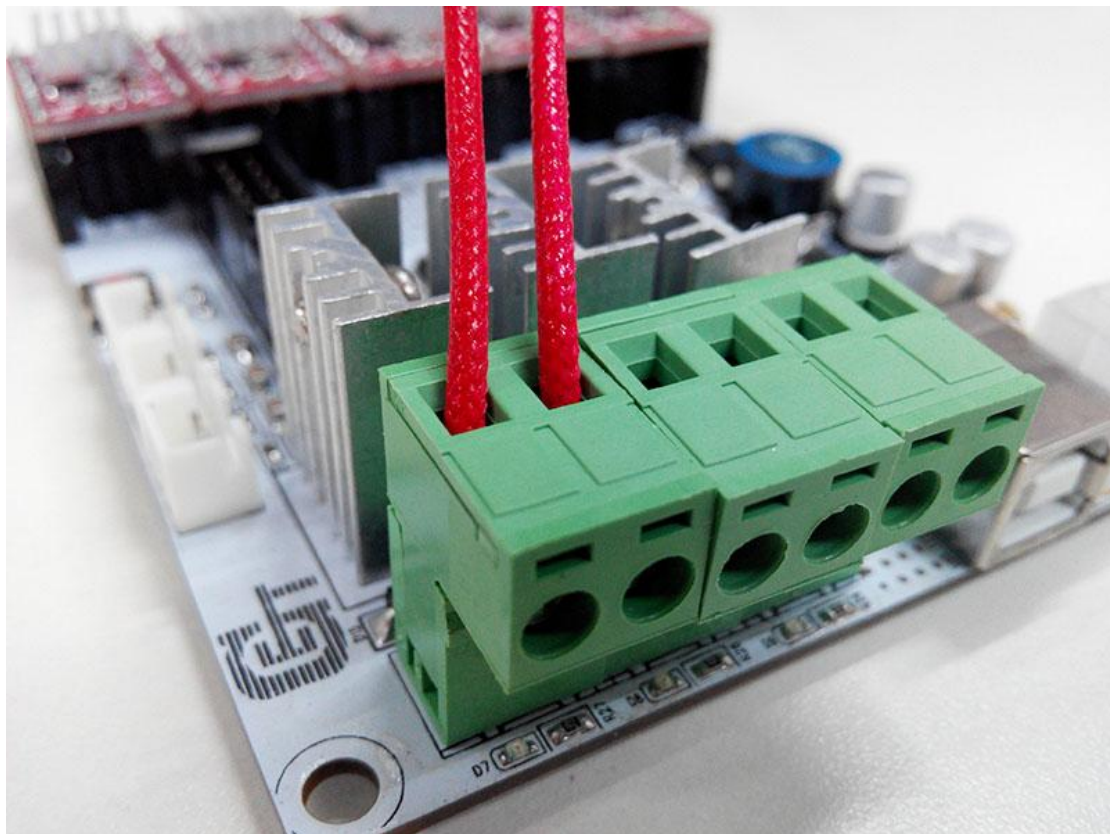

3) Connect heating wires for extruder 2.

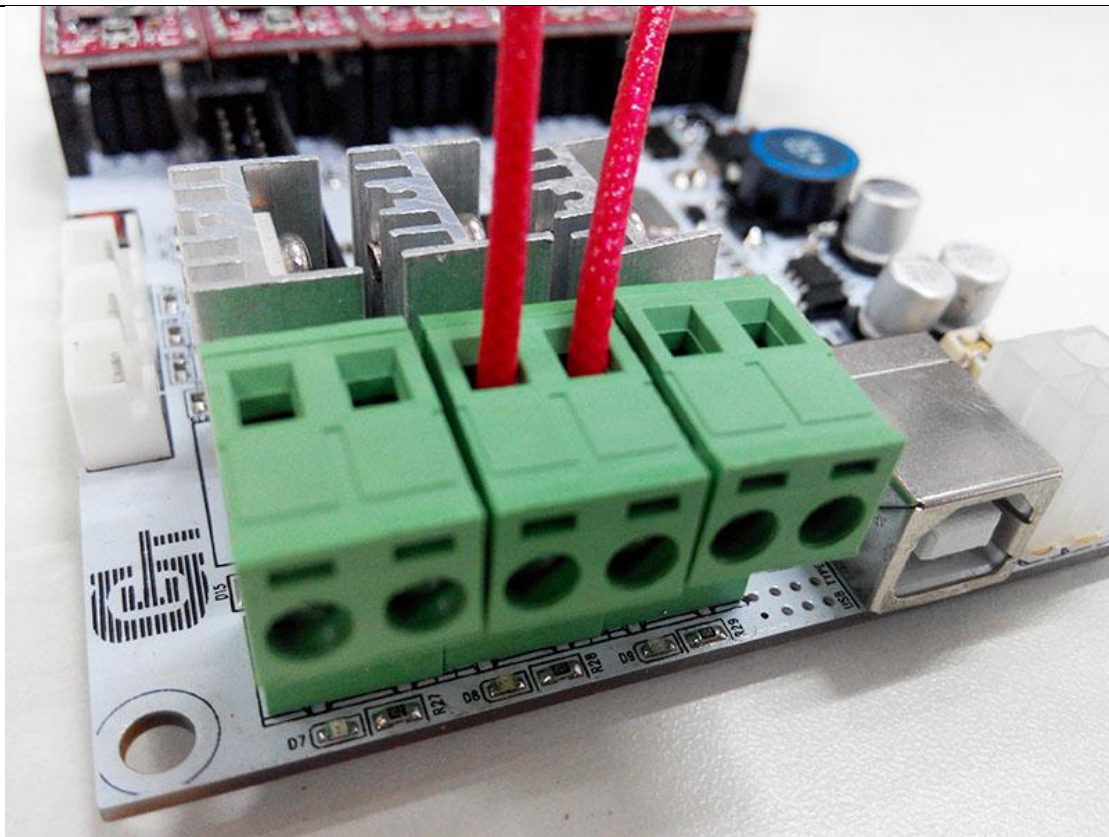

**Step5. Connect wires for thermistor.**

- 1) Connect wires for thermistor of heated.

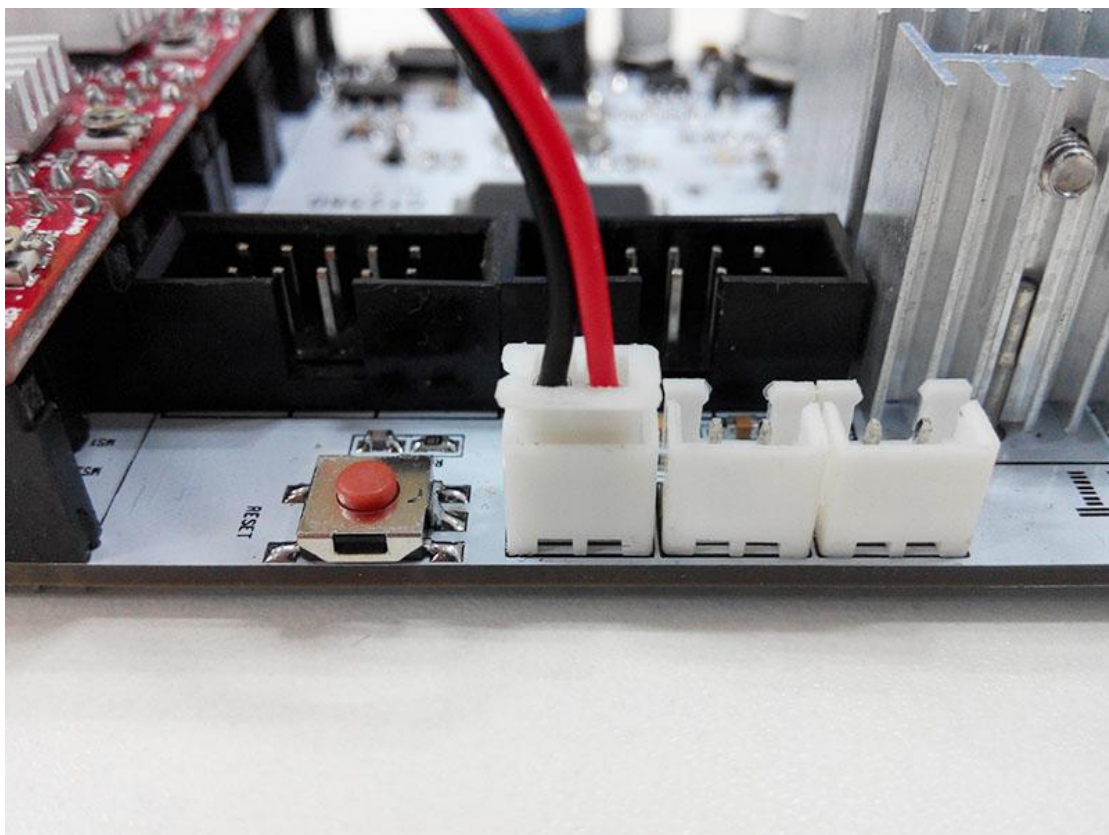

2) Connect wires for thermistor of extruder 1.

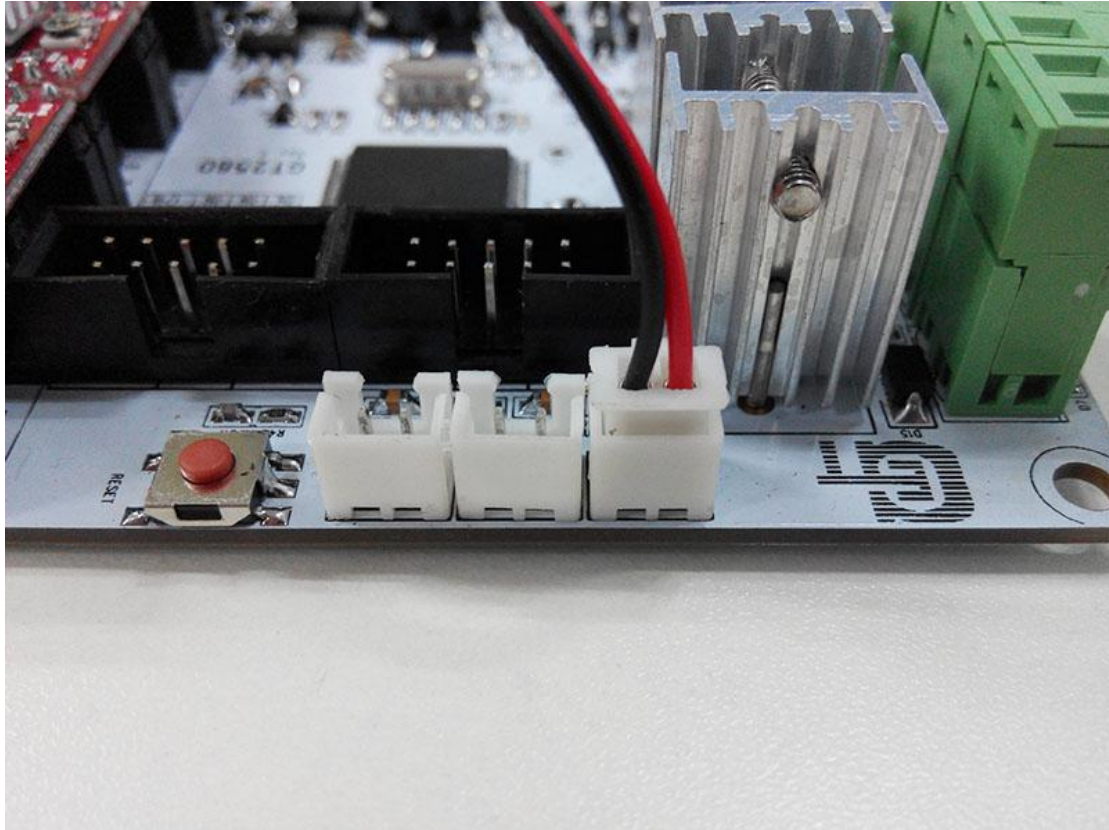

3) Connect wires for thermistor of extruder 2.

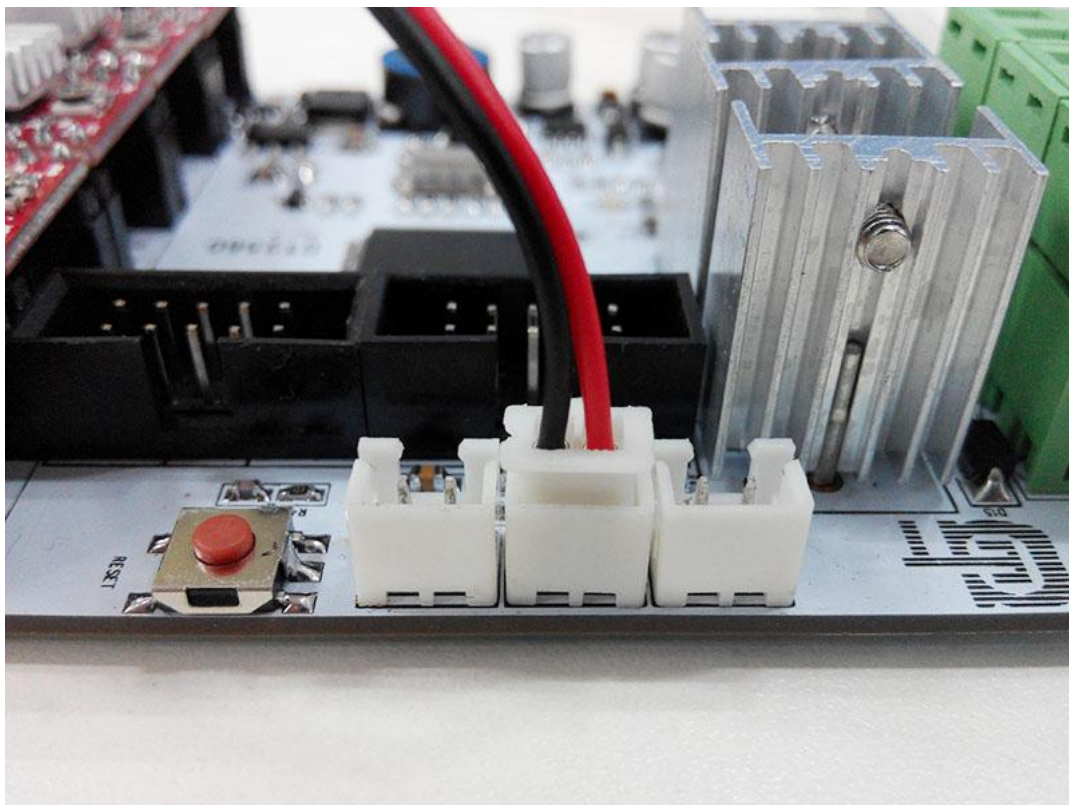

Step6. Connect wires for endstop. 1) Connect wires for endstop of X-axis at X-Min.

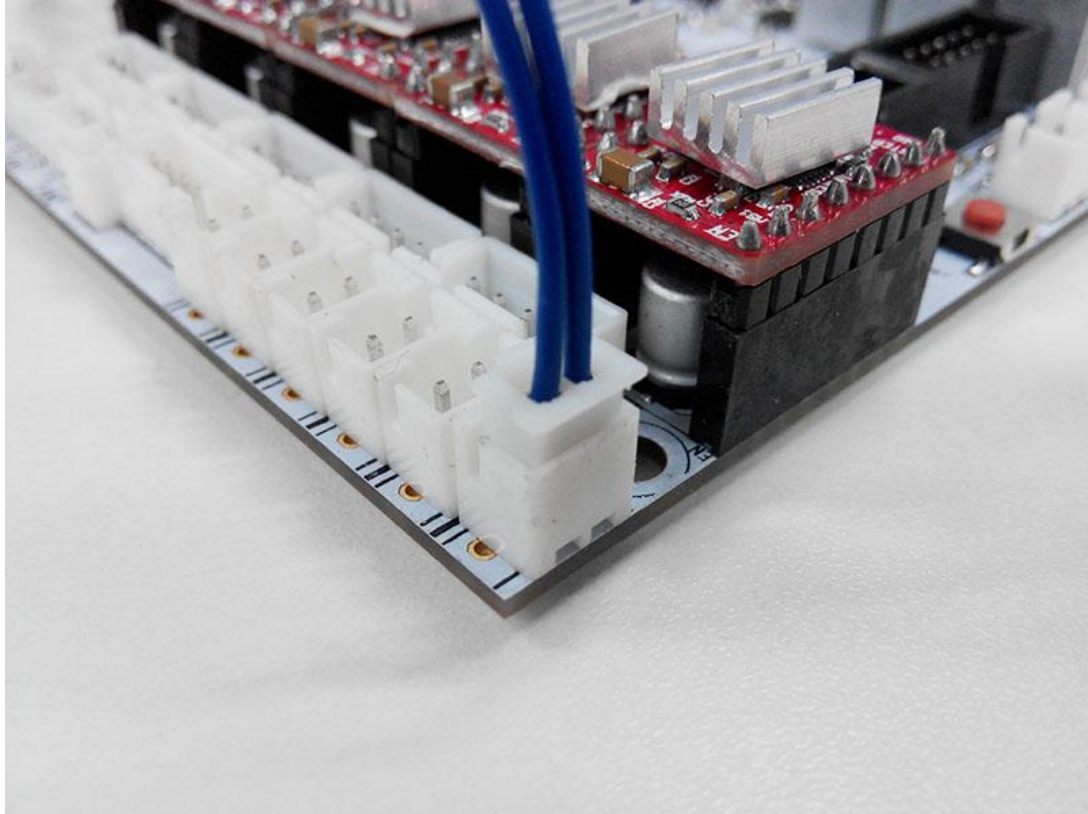

2) Connect wires for endstop of Y-axis at Y-Min.

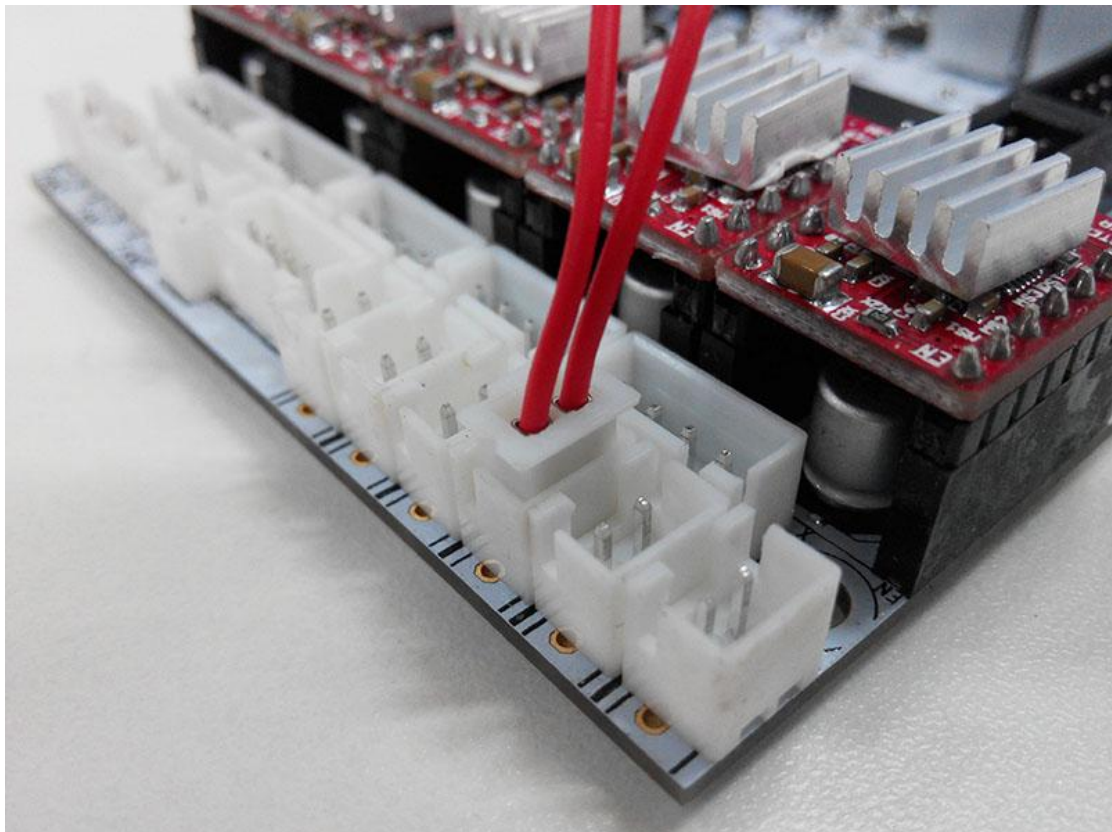

3) Connect wires for endstop of Z-axis at Z-Min.

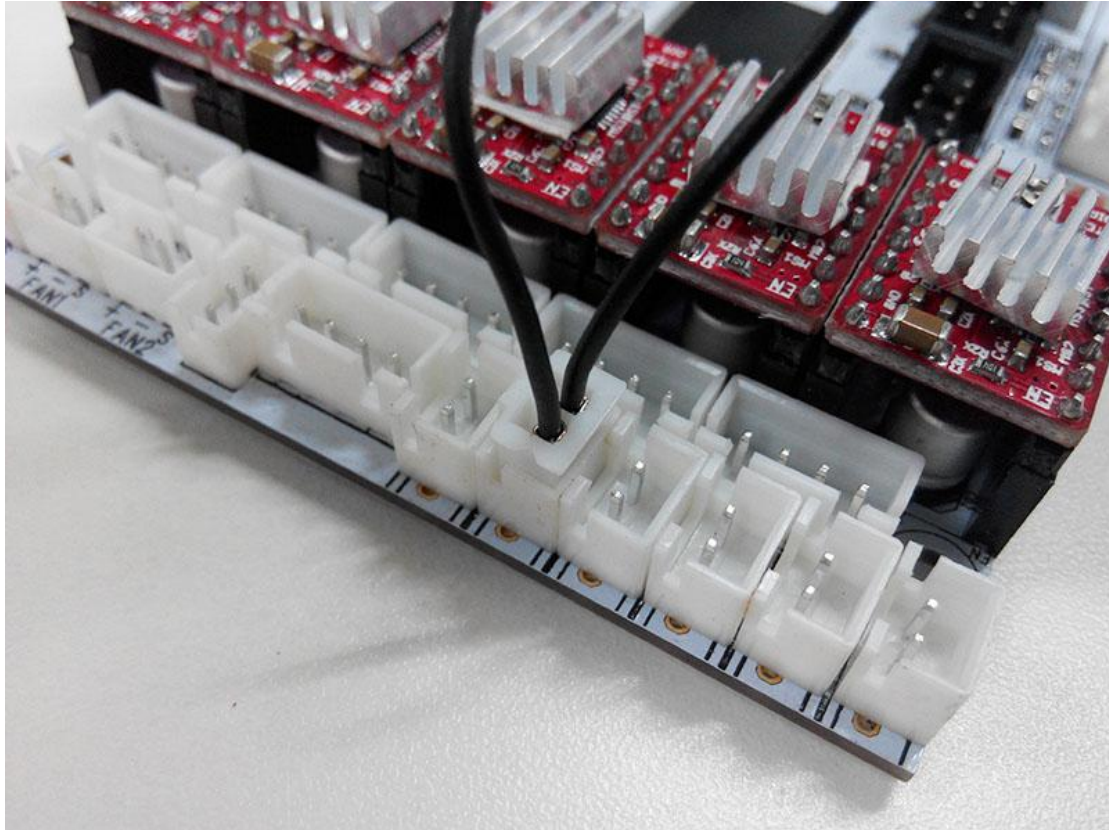

**Step7. Connect wires for Fan.** 1) Connect fan for control board at FAN3.

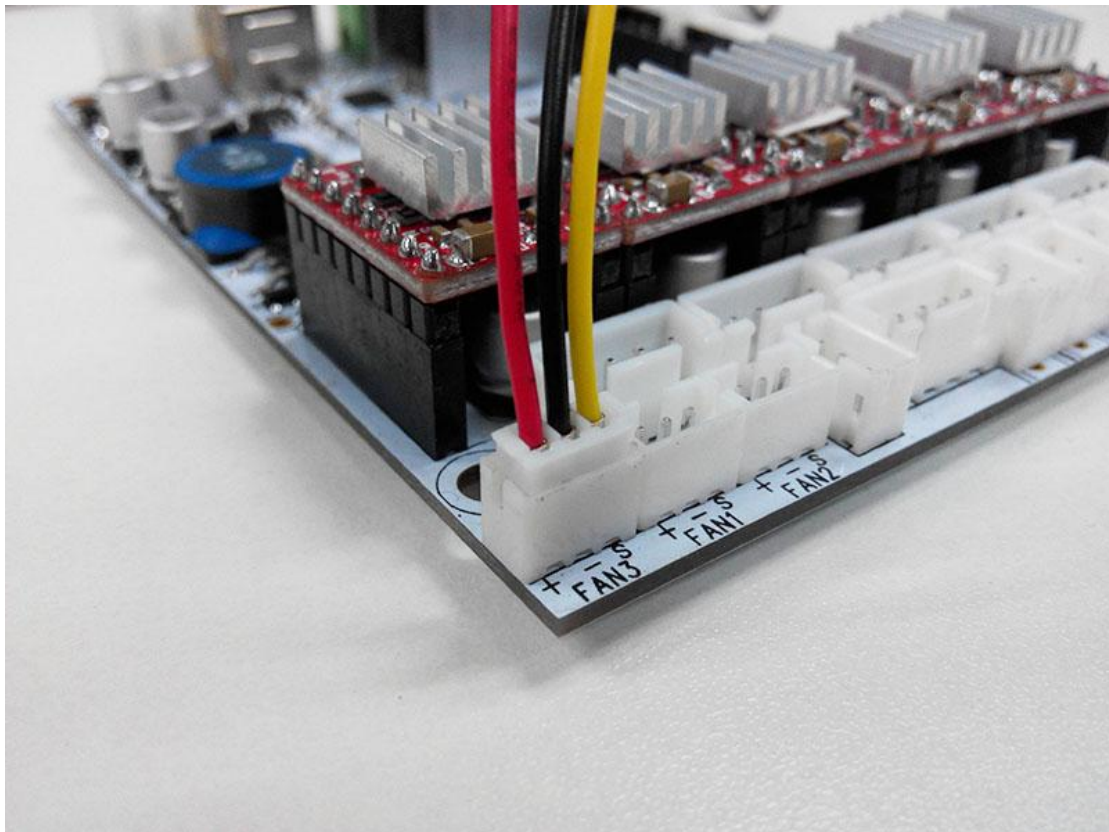

2) Connect fan for extruder at FAN1.

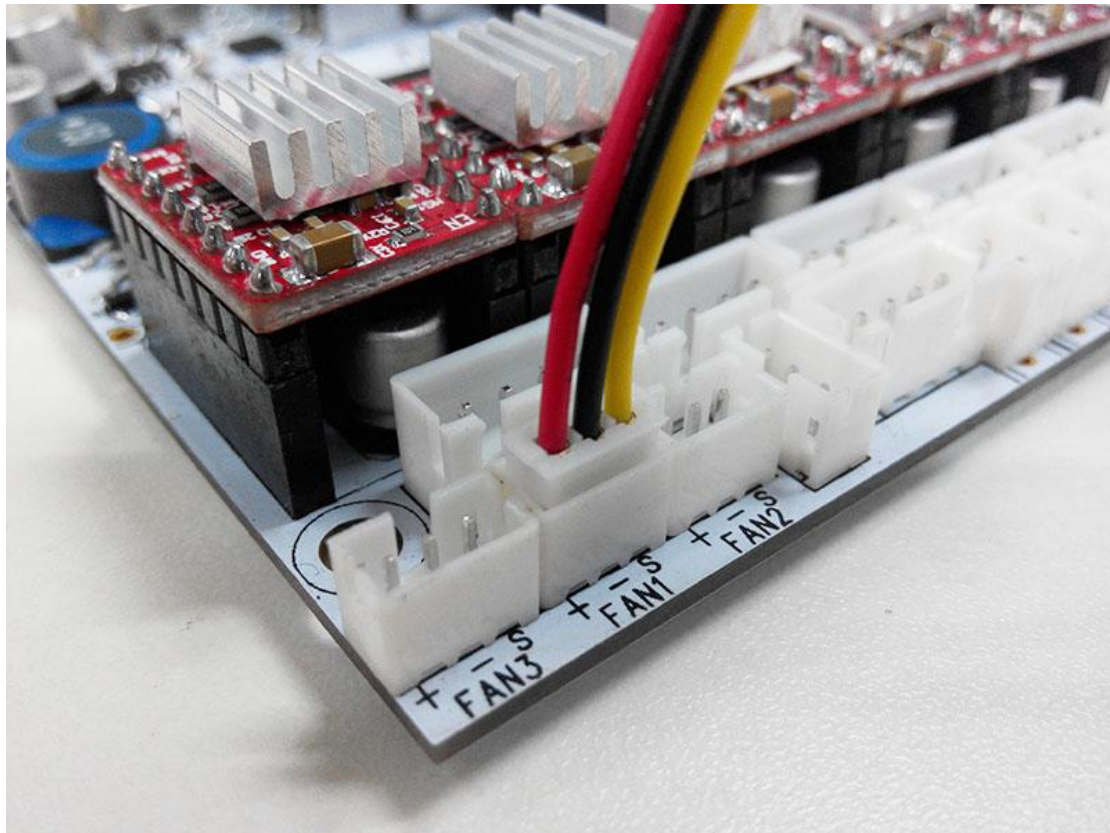

If you use the 2-pin extension wire for the fan, just plug them on the **+** and **-** pin.

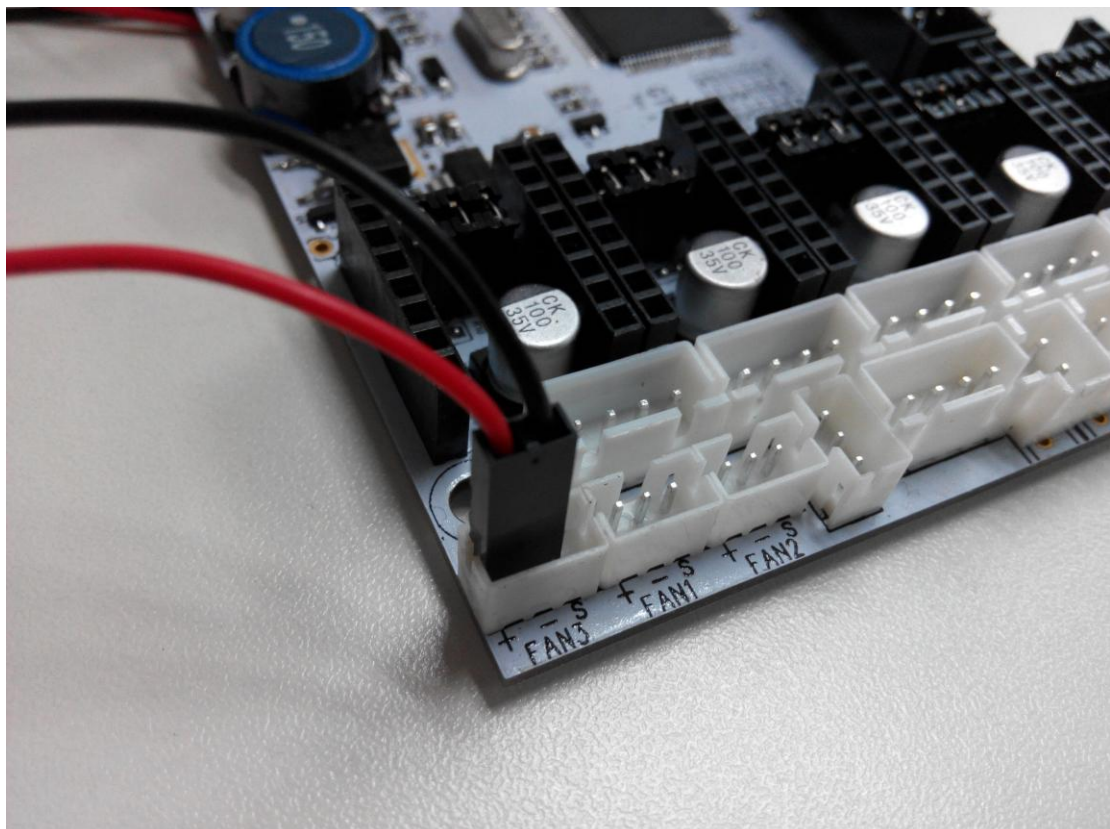



**Step8. Connect wires for LCD panel.**

There are two cables, one is for LCD encoder, the other is for SD card.

EXP1 to LCD

EXP2 to SD card reader

\* Note: There is a small screw above the SD card reader. If the LCD text display is not very clear, you can make some adjustments with this screw to improve the displayed text. Do not over turn or apply aggressive force as you may damage the potentiometer.

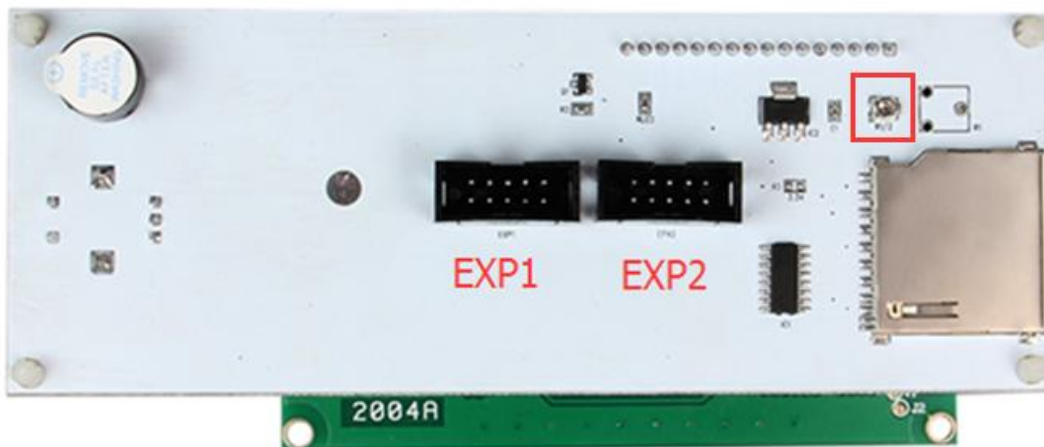

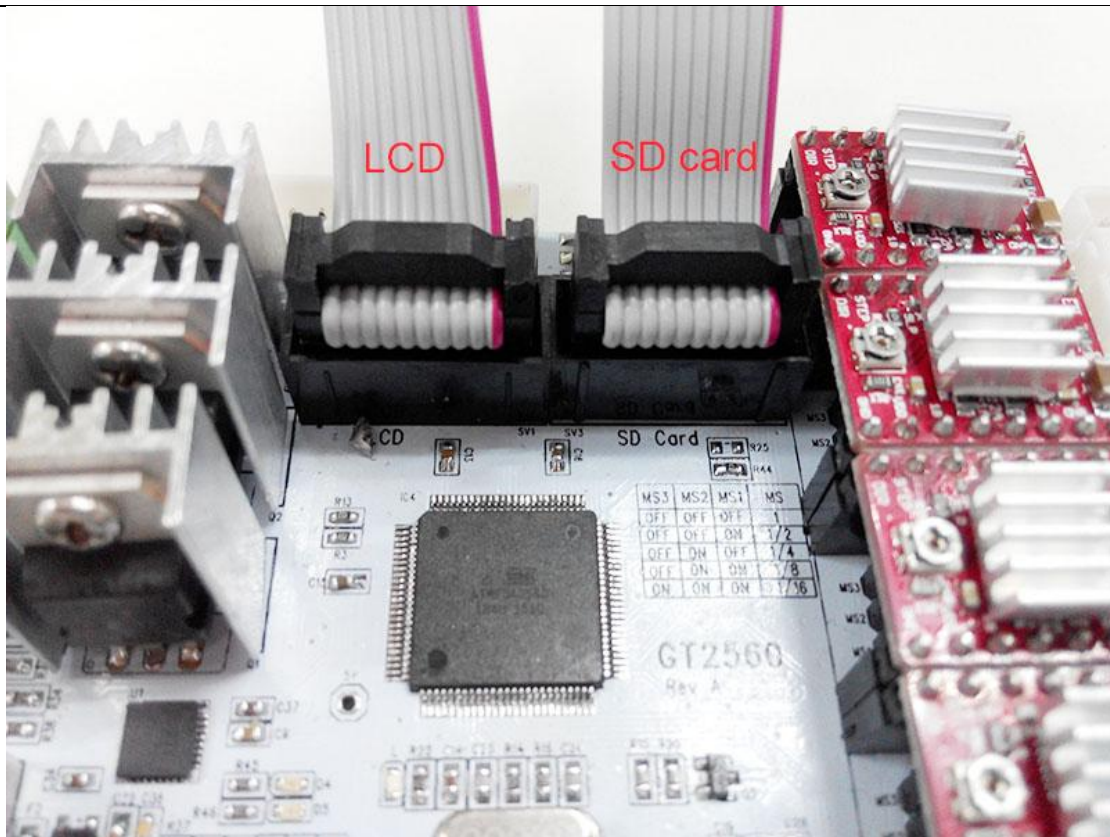



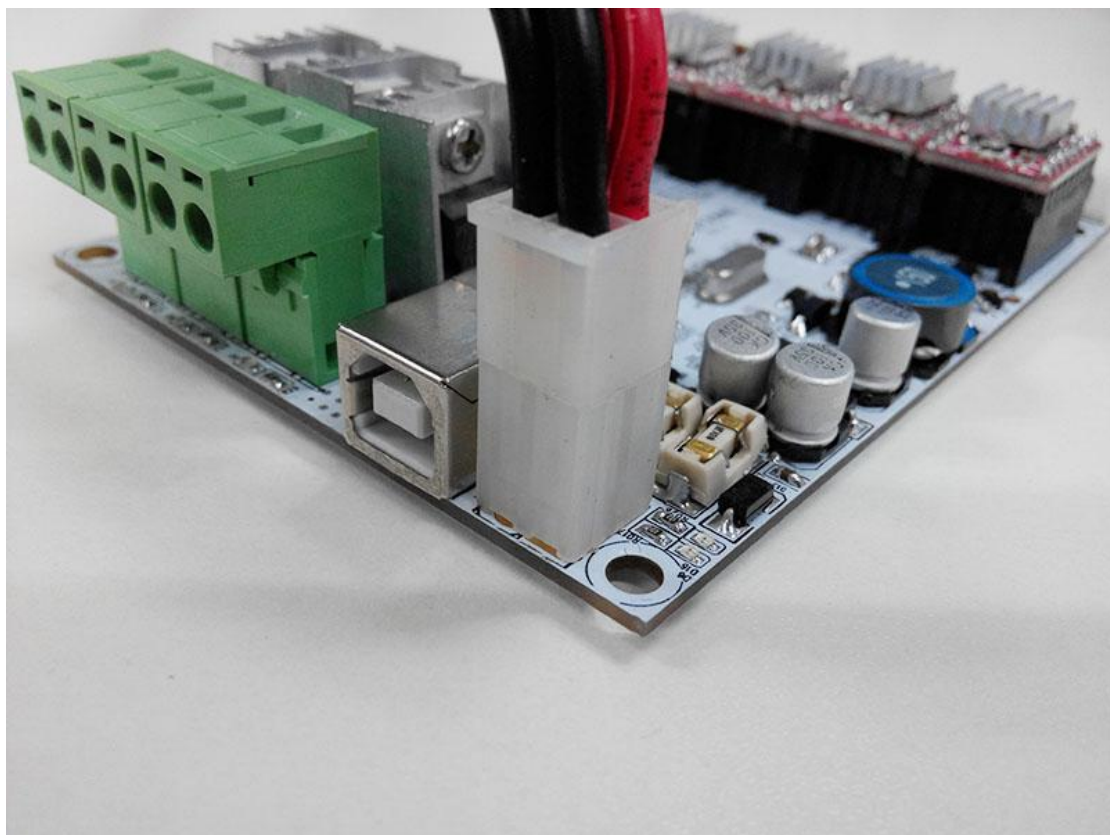

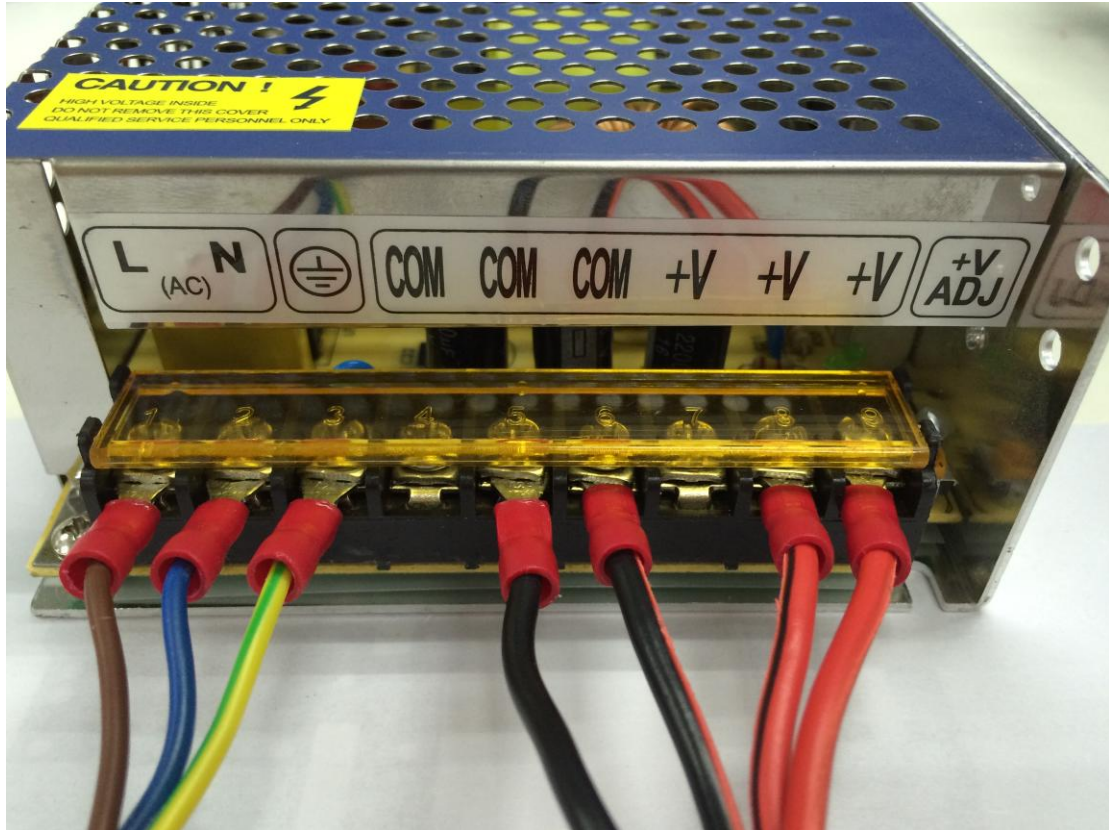

**Step9. Connect wires for power input.**



Step 10. Connect the wires to the PSU.









Note the correspondence between the color of wires and the connector.

- BROWN  Live (L)
- BLUE  Neutral (N)
- GREEN /  Ground (GND)  
YELLOW
- RED  Positive (+)
- BLACK  Common (COM)

That is all for the wiring of GT2560.

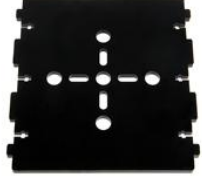
**26. Mount the filament spool.**

Part name	Part ID	Required number	pic
M3 x 16mm screw	No.23	6	

M3 Square nut	No.16	6	
M3 washer	No.7	6	
Spool base plate		1	
Spool side pane		2	
PVC tube		1	
PVC tube		2	

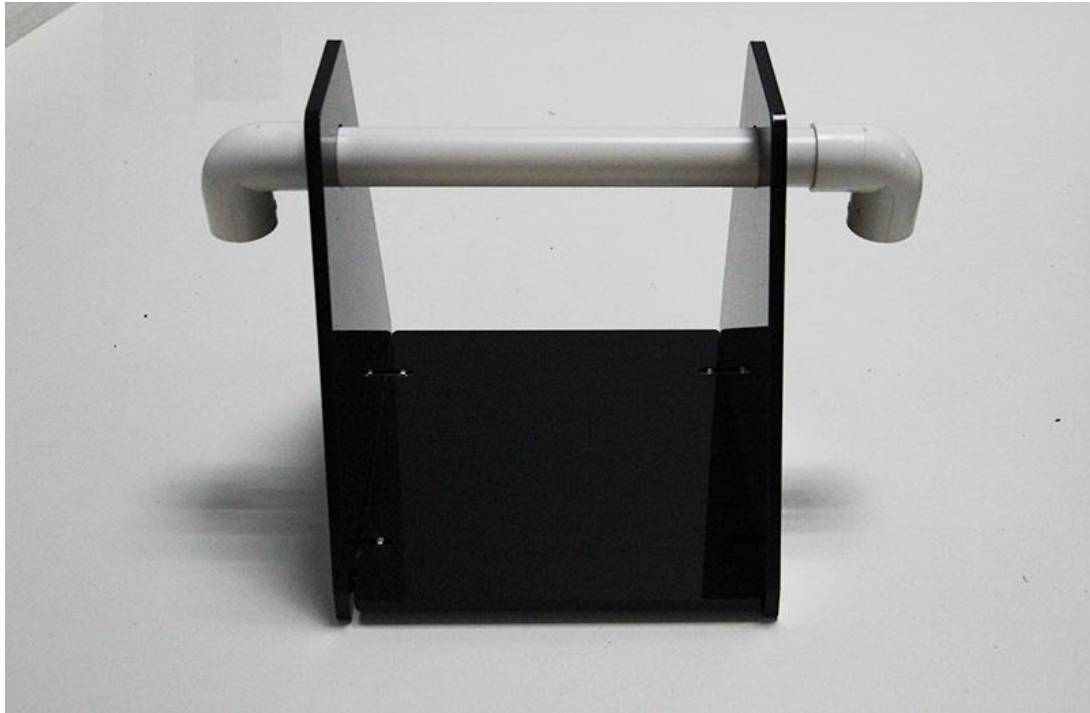

So far, the whole printer is built up, you can tidy up the wires with the zip ties and the coil wire.

Before even attempting the first print it is vital that the printer is correctly calibrated. Skipping or rushing this step will result in frustration and failed prints later, so it is important to take the time to make sure the machine is correctly set up.

Each machine may have its own calibration procedure and this manual will not attempt to cover all the variations. Instead here is a list of key points that should be addressed.

- Frame is stable and correctly aligned.
- Belts are taut.
- Bed is level in relation to the path of the extruder.
- Filament rolls freely from the spool, without causing too much tension on the extruder.
- Current for stepper motors is set to the correct level.

Firmware settings are correct including: axis movement speeds and acceleration; temperature control; end-stops; motor directions.

Extruder is calibrated in the firmware with the correct steps per mm of filament.

The point regarding the extruder step rate is vital. Slic3r expects that the machine will accurately produce a set amount of filament when told to do so. Too much will result in blobs and other imperfections in the print. Too little will result in gaps and poor inter-layer adhesion.

